

ERTMS/ETCS

Interface 'G' Specification

REF : SUBSET-100

ISSUE : 2.0.0

DATE : February 24, 2012

Company	Technical Approval	Management approval
ALSTOM		
ANSALDO		
BOMBARDIER		
INVENSYS		
SIEMENS		
THALES		

© This document has been developed and released by UNISIG

MODIFICATION HISTORY

Issue Number Date	Section Number	Modification / Description	Author
0.0.1, 2003-09-25		Initial draft based on restructured BVS 544.39002 of August 15, 2000. No technical modifications.	P. Lundberg
0.0.2, 2003-11-24		Including published input from Ansaldo and Bombardier, and additional contribution from Bombardier.	P. Lundberg
0.0.3, 2003-12-04		Update considering conclusions from the second WGKI meeting.	P. Lundberg
0.0.4, 2004-02-06		Update considering conclusions from the third WGKI meeting.	P. Lundberg
0.0.5, 2004-03-19		Update considering conclusions from the fourth WGKI meeting.	P. Lundberg
0.0.6, 2004-05-06		Update considering conclusions from the fifth WGKI meeting.	P. Lundberg
0.0.7 2004-08-09		Update considering conclusions from the sixth and seventh WGKI meetings.	P. Lundberg
0.0.8 2004-10-28		Update considering conclusions from the eighth, ninth, and tenth WGKI meetings.	P. Lundberg
0.0.9 2004-12-03		Update considering discussions from the eleventh WGKI meeting.	P. Lundberg
0.0.10 2005-01-14		Update considering comments from Ansaldo and discussions from the twelfth WGKI meeting.	P. Lundberg
0.0.11 2005-02-17		Update considering comments from Ansaldo and discussions from the thirteenth WGKI meeting.	P. Lundberg
0.0.12 2005-02-25		Update considering conclusions via e-mail.	P. Lundberg
0.1.0 2005-03-09		First official draft.	P. Lundberg

Issue Number Date	Section Number	Modification / Description	Author
0.1.1 2005-05-13		Update considering conclusions from the fifteenth and sixteenth WGKI meetings.	P. Lundberg
0.1.2 2005-06-15		Update considering input on KVB Balises.	P. Lundberg
0.2.0 2005-06-23		Second official draft.	P. Lundberg
1.0.0 2005-10-04	3.1.3.2 and 3.1.3.3	Final update.	P. Lundberg
1.0.1 2005-11-18	3.1.3.2	Deletion of statement on member state responsibility in accordance with CG agreements of November 16, 2005.	P. Lundberg
1.0.2 2012-02-20		Removal of "Class 1" and update of company names on front page.	P. Lundberg
2.0.0 2012-02-24		Baseline 3 release version (only change of Issue number).	P. Lundberg

Foreword

This document is the specification for the air-gap Interface 'G' between the On-board antenna unit and the national wayside Balises.

Contents

1	GENERAL	10
1.1	Scope	10
1.2	Introduction	12
1.3	Functional Description	15
2	TERMINOLOGY	16
2.1	Abbreviations	16
2.2	Acronyms	17
2.3	Definitions	18
2.4	Reference Positioning System	22
2.4.1	General	22
2.4.2	Reference Marks	22
2.4.3	Rotation Axes	23
2.4.4	Reference Axes, Installation Requirements	25
2.4.5	Influence from Rail Wear	26
2.5	Definition of Test Tolerances	26
3	PHYSICAL TRANSMISSION	27
3.1	Tele-powering (G4) Physical Transmission	27
3.1.1	Transmission Medium	27
3.1.2	Mechanical Data	27
3.1.3	Tele-powering Electrical Data	27
3.2	Up-link (G1) Physical Transmission	30
3.2.1	Transmission Medium	30
3.2.2	Mechanical Data	30
3.2.3	Up-link Electrical Data	30
4	PHYSICAL INTERACTION AND ENVIRONMENT	32
4.1	Antenna Unit and Balise Interaction	32
4.2	Balise Reference Area	32
4.3	Air gap Transmission Requirements	33
4.3.1	General	33
4.3.2	Field Conformity	33
4.3.3	Transmission in the Contact Zone	36
4.3.4	Transmission in the Cross-talk Positions	41
4.4	Procedure Control and Error Handling	43

4.4.1	Side lobe Filtering	43
4.4.2	Balise Detect	43
4.5	Balise Installation Requirements	43
4.5.1	General	43
4.5.2	Balise Orientation in Relation to the Rails	44
4.5.3	Mounting Distances between Balises	44
4.5.4	Metal Free Volume	45
4.5.5	Mounting to Sleeper	46
4.5.6	Guard Rails	46
4.5.7	Interfering Conductive Cables	46
4.6	Antenna Unit Installation Requirements	50
4.6.1	General	50
4.6.2	Allowed Displacement for the Antenna Units	50
4.6.3	Metal masses in the Track	50
4.6.4	Antenna positioning along the x-axis	50
4.7	Debris and Mismatch	51
4.8	EMI and EMC	52
4.8.1	In-band Emission	52
4.8.2	Out-band Emission	53
4.8.3	Susceptibility	53
5	UP-LINK (G1) PROTOCOL	54
5.1	Start-up of the Transmission Link	54
5.2	Code Protection	54
5.3	Handshaking	54
5.4	Disconnection	54
5.5	Mode Transfer Syntax	54
6	RAMS REQUIREMENTS	55
6.1	Transmission System Aspects	55
6.1.1	General	55
6.1.2	Top-level Functionality	55
6.1.3	Reliability	55
6.1.4	Availability	55
6.1.5	Maintainability	55
6.1.6	Safety Related Functionality	56
6.1.7	Top-level Failure Modes	58

6.2	Balise Aspects	59
6.2.1	General	59
6.2.2	Balise Functionality	59
6.3	On-board Equipment Aspects	61
6.3.1	Antenna and BTM Safety Functional Requirements	61
6.3.2	Safety Integrity Requirements	63
7	REFERENCES	65
ANNEX A, BALISE TYPE A SPECIFIC PARAMETERS		66
A1	GENERAL	66
A2	TIMING REQUIREMENTS	66
A3	INPUT-TO-OUTPUT CHARACTERISTICS	66
A4	BALISE IMPEDANCE	67
A5	START-UP TIME OF THE BALISE	67
ANNEX B, BALISE TYPE B SPECIFIC PARAMETERS		68
B1	GENERAL	68
B2	TIMING REQUIREMENTS	68
B3	INPUT-TO-OUTPUT CHARACTERISTICS	68
B4	BALISE IMPEDANCE	69
B5	START-UP TIME OF THE BALISE	69
ANNEX C, BALISE TYPE C SPECIFIC PARAMETERS		70
C1	GENERAL	70
C2	TIMING REQUIREMENTS	70
C3	INPUT-TO-OUTPUT CHARACTERISTICS	70
C4	BALISE IMPEDANCE	71
C5	START-UP TIME OF THE BALISE	71
ANNEX D, BALISE TYPE D SPECIFIC PARAMETERS		72
D1	GENERAL	72
D2	TIMING REQUIREMENTS	72

D3	INPUT-TO-OUTPUT CHARACTERISTICS	72
D4	BALISE IMPEDANCE	73
D5	START-UP TIME OF THE BALISE	73
ANNEX E, BALISE TYPE E SPECIFIC PARAMETERS		74
E1	GENERAL	74
E2	TIMING REQUIREMENTS	74
E3	INPUT-TO-OUTPUT CHARACTERISTICS	74
E4	BALISE IMPEDANCE	75
E5	START-UP TIME OF THE BALISE	75
ANNEX F, ANTENNA UNIT DISPLACEMENTS		76
F1	ANTENNA UNIT DISPLACEMENTS	76
ANNEX G, DEBRIS AND MISMATCH		77
G1	DEBRIS AND MISMATCH	77
ANNEX H, BALISE ORIENTATION IN RELATION TO THE RAILS		80
H1	GENERAL	80
H2	GENERAL BALISE INSTALLATION APPLICATIONS	80
H3	COUNTRY SPECIFIC INSTALLATION APPLICATIONS	81
H3.1	General	81
H3.2	Ebicab 700 Transmission System, Sweden	81
H3.2.1	Change of Vertical Position of the Balise	81
H3.2.2	Cutting of Guard Rails close to a Balise	81
H3.3	Ebicab 700 Transmission System, Norway	82
H3.3.1	Change of Vertical Position of the Balise	82
H3.3.2	Cutting of Guard Rails close to a Balise	82
H3.4	KVB Transmission System, France	83
H3.4.1	Change of Vertical Position of the Balise	83
H3.4.2	Lateral Deviation of the Balise	83
H3.4.3	Presence of Metallic Objects	83
H3.4.4	Distance Between Balises	83
ANNEX J, ON-BOARD TYPE 1 SPECIFICS		84

J1	GENERAL	84
J2	SPECIFIC SAFETY REQUIREMENTS	84
J3	SAFETY INTEGRITY REQUIREMENTS	84
J4	CONTACT DISTANCE FOR TELEGRAM DECODING	85
J5	ANTENNA POSITIONING ALONG THE X-AXIS	85
ANNEX K, ON-BOARD TYPE 2 SPECIFICS		86
K1	GENERAL	86
K2	SPECIFIC SAFETY REQUIREMENTS	86
K3	SAFETY INTEGRITY REQUIREMENTS	86
K4	CONTACT DISTANCE FOR TELEGRAM DECODING	87
K5	ANTENNA POSITIONING ALONG THE X-AXIS	87
ANNEX L, ON-BOARD TYPE 3 SPECIFICS		88
L1	GENERAL	88
L2	SPECIFIC SAFETY REQUIREMENTS	88
L3	SAFETY INTEGRITY REQUIREMENTS	88
L4	CONTACT DISTANCE FOR TELEGRAM DECODING	89
L5	ANTENNA POSITIONING ALONG THE X-AXIS	89
ANNEX M, ON-BOARD TYPE 4 SPECIFICS		90
M1	GENERAL	90
M2	SPECIFIC SAFETY REQUIREMENTS	90
M3	SAFETY INTEGRITY REQUIREMENTS	90
M4	CONTACT DISTANCE FOR TELEGRAM DECODING	91
M5	ANTENNA POSITIONING ALONG THE X-AXIS	92

1 General

1.1 Scope

This document defines the air gap, Interface ‘G’, between the Balise and the combination of the On-board Transmission Equipment and the KER STM of the related national Balise Transmission Systems using the same frequency ranges as Eurobalise.

The purpose of this document is to provide all necessary information, and define all necessary parameters, in order to facilitate that an ERTMS On-board ATP will be able to read national Balises denominated KER Balises.

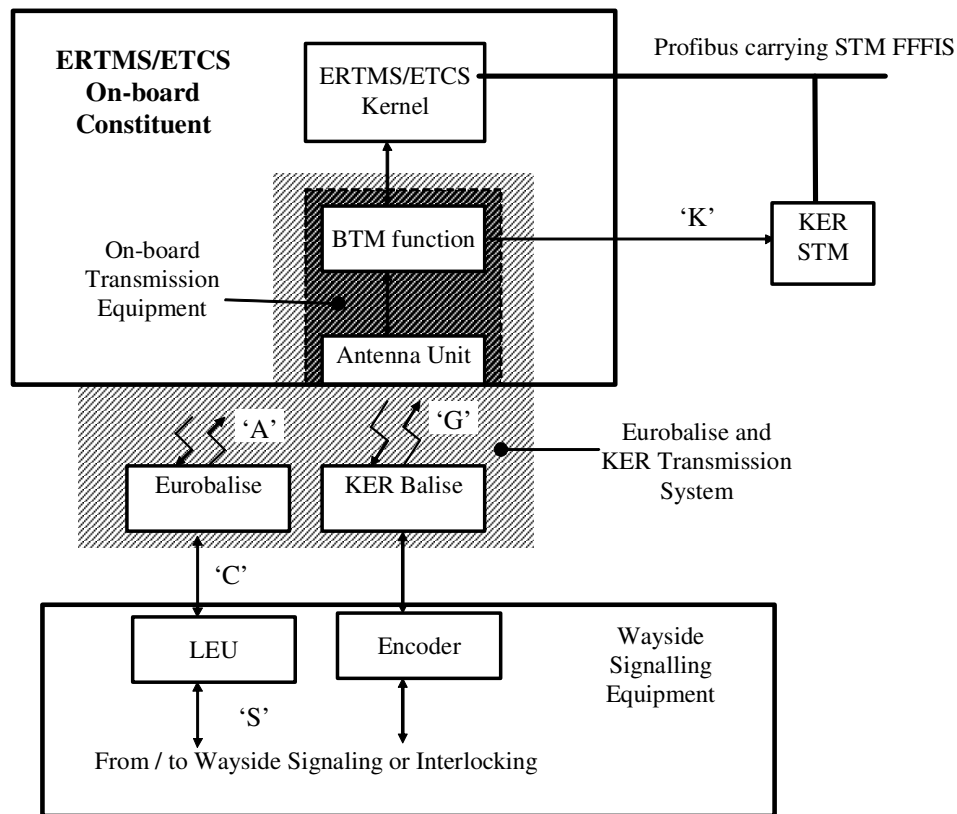

Figure 1: General Architecture

In conjunction with UNISIG SUBSET-101 (see Ref. [6]), defining the Interface ‘K’, the herein given information and parameters will provide the possibility to design an On-board transmission sub-system (antenna + BTM function) able to detect and read national KER type Balises and transmit the received information bits to the associated national STM. This optional service is only necessary when connecting the national STM that requires this feature. The application of this document could be limited to the parts relating to the infrastructure where this service will be used in operation.

In the following, Balise refers to national KER Balises unless otherwise explicitly mentioned.

This document provides also all necessary information needed for demonstrating that an On-board equipment is interoperable with the existing national infrastructure.

This document specifically defines the characteristics and the performance of the air gap between the Balise and the On-board Transmission Equipment regarding:

- The characteristics of the signals in the air gap.
- The air gap performance of the Balise.
- The installation conditions of the Balise.

This document also provides information necessary for testing the On-board equipment in order to demonstrate the capability to fulfil the requirements of existing infrastructure.

The general parameters of the Interface 'G' are specified in this document, and the specific parameters are specified in annexes at the end of the document.

The specific parameters consist of product specific parameters and country specific parameters. The product specific parameters are specific parameters for the Balises, such as certain timing parameters. The country specific parameters are specific parameters that are valid in a certain country only, i.e., various Balise installation conditions.

This specification is valid for new On-board systems based on the ERTMS/ETCS concept only. For already delivered On-board systems used in the original KER systems, the air-gap specifications that were the basis at that time apply.

1.2 Introduction

Interface 'G' is a two-way communication interface:

- From the On-board Transmission Equipment to the Balise, Tele-powering ('G4').
- From the Balise to the On-board Transmission Equipment, Up-link ('G1').

The denomination Interface 'G' refers to both Up-link and Tele-powering.

The Balises of Interface 'G' covered by this specification can be of types as clarified in Table 1 below.

Interface	Balise Type	Example of product
G _A	A	Parallel/Grey Balise in Sweden and Norway
G _B	B	Serial Balise in Sweden
G _C	C	Mini Balise in Norway
G _D	D	Parallel Balise in France
G _E	E	Serial Balise in France

Table 1: Identification of Balises and Interfaces

The national infrastructure owner should define which Balise types that are applicable, and which STM that is approved for use (implicitly defining the requirements on the BTM and antenna).

Interface 'G' has a signal layer, a physical signal layer, a coding layer, and a data layer. Table 2 below defines the applicability of the various parts of this specification for the involved countries.

Country	Signal Layer	Physical Layer	Coding and Data Layers
Finland	Main Document Annex B Annex C	Main Document Annex H, section H2	Application Unique
France	Main Document Annex D Annex E	Main Document Annex H, section H2 Annex H, section H3	Application Unique
Italy	Main Document Annex A Annex C	Main Document Annex H, section H2	Application Unique
Norway	Main Document Annex A Annex B Annex C	Main Document Annex H, section H2 Annex H, section H3	Application Unique
Portugal	Main Document Annex A Annex B	Main Document Annex H, section H2	Application Unique
Spain	Main Document Annex B	Main Document Annex H, section H2	Application Unique
Sweden	Main Document Annex A Annex B	Main Document Annex H, section H2 Annex H, section H3	Application Unique

Table 2: Applicability versus countries

Specific air gap interfaces are defined depending on the type of Balises being used.

- Interface 'G_A' is the air gap interface between the Balise Type A and the On-board Transmission Equipment of an ASK Balise Transmission System. Specific parameters are defined in Annex A.
- Interface 'G_B' is the air gap interface between the Balise Type B and the On-board Transmission Equipment of an ASK Balise Transmission System. Specific parameters are defined in Annex B.
- Interface 'G_C' is the air gap interface between the Balise Type C and the On-board Transmission Equipment of an ASK Balise Transmission System. Specific parameters are defined in Annex C.
- Interface 'G_D' is the air gap interface between the Balise Type D and the On-board Transmission Equipment of an ASK Balise Transmission System. Specific parameters are defined in Annex D.
- Interface 'G_E' is the air gap interface between the Balise Type E and the On-board Transmission Equipment of an ASK Balise Transmission System. Specific parameters are defined in Annex E.

In addition to this, there are several country specific applications defined in the annexes at the end of this document.

The specific interfaces are similar to each other, except for a few parameters that are stated separately in annexes at the end of this document. The requirements stated in the main document apply for all the specific interfaces.

This document does not separate the interfaces further with respect to what type of On-board Transmission Equipment that is used. The specific parameters such as antenna unit installation, Balise Detect criteria, etc. for the combination of the On-board Transmission Equipment and the KER STM, are not considered in this document.

Interface 'G' consists of various interfaces depending on the type of Balise that are used. See Figure 2 below. X in the figure refers to any of the Balise types defined in Table 1.

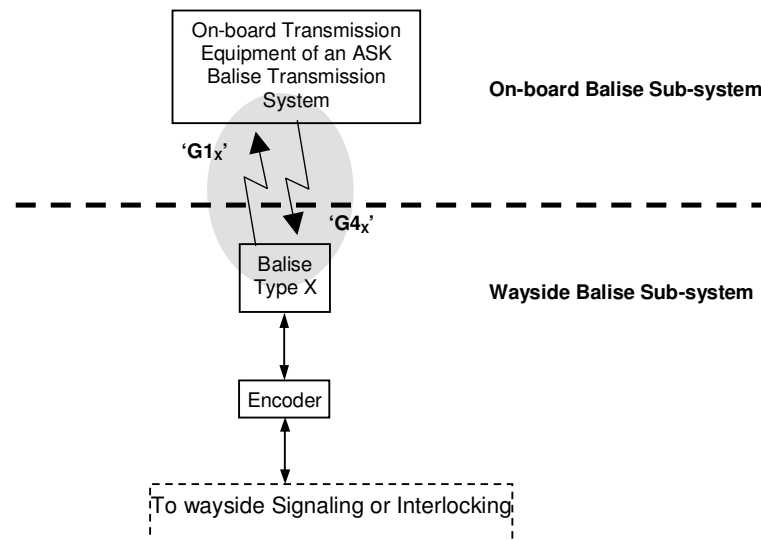

Figure 2: Interface 'G'

The common parts of the various interfaces of Interface 'G' are defined in the main part of this specification, and the product and country specific parameters are defined in annexes at the end of the document.

If an index is excluded in the denomination of an interface, it shall be seen as a wildcard, e.g., Interface 'G_A' refers to both the Tele-powering and Up-link interfaces between the Balise Type A, and the On-board Transmission Equipment of the ASK Balise Transmission System.

In this document, the word 'Balise' refers to a Balise that fulfils applicable parts of the Interface 'G' specification.

The values in this document are based on tests and previous experience.

The safety related requirements are marked with an **S** in the left margin.

Terms and definitions are defined chapter 2 on page 16.

1.3 Functional Description

The ASK Balise Transmission Systems are safe, spot transmission based systems that use Balises as a means for transmission. These systems convey safety-related data between the wayside infrastructure and the train.

The transmission of data between the Wayside Balise Equipment and the On-board Transmission Equipment (Interface 'G') shall use magnetic coupling in the air gap.

The national On-board antenna unit emits a magnetic field for powering of the Balise. The carrier frequency shall be 27.095 MHz or 27.115 MHz. For some existing transmission systems, the carrier frequency is 27.115 MHz, and there is no functional difference between the use of any of the two frequencies. The carrier frequency shall for both frequencies be amplitude modulated with a 50 kHz synchronisation signal, called "non-toggling" 50 kHz modulation.

The Balise mainly uses the vertical component of the magnetic field. When the antenna unit is in the contact volume, energy is induced in the Balise reception loop. The Balise responds by sending an amplitude shift keyed (ASK) signal using a carrier frequency of approximately 4.5 MHz. The amplitude of the pulse is decreasing exponentially during the pulse. The data rate from the Balise is 50 kbit/s, which is synchronised with the 50 kHz modulation of the magnetic field from the antenna.

A Eurobalise On-board Transmission Equipment that operates in interoperable mode transmits a 50 kHz synchronisation signal that is pulse width modulated onto the 27.095 MHz carrier frequency (called "toggling" 50 kHz modulation), to which the Balise also shall respond by sending its telegram. Toggling modulation is defined in section 3.1.3.3 on page 29.

Interoperable Eurobalises (not covered by this specification) will only respond to the toggling modulation, but not to the non-toggling modulation.

A Eurobalise On-board Transmission Equipment that operates in compatible mode transmits a continuous wave carrier (27.095 MHz), to which the Balise do not respond.

2 Terminology

2.1 Abbreviations

The following common abbreviations are used.

Abbreviation	Definition
A	Ampere
dB	decibel
dBc	dB relative to carrier
h	hour
Hz	Hertz
m	meter
ppm	parts per million
Ref.	Reference
s	second
V	Volt
Ω	Ohm

2.2 Acronyms

In general, the acronyms of UNISIG SUBSET-023 apply. Additionally, the following list of acronyms applies within this specification:

Acronym	Description
AM	Amplitude Modulation
ASK	Amplitude Shift Keying
ATP	Automatic Train Protection
BTM	Balise Transmission Module
CW	Continuous Wave
DC	Direct Current
Ebicab	Bombardier Transportation (Signal) ATP system
EMC	Electro Magnetic Compatibility
EMI	Electro Magnetic Interference
FFFIS	Form Fit Function Interface Specification
KER	KVB, Ebicab, RSDD
KVB	Controle de Vitesse par Balise; French ATP system
N/A	Not Applicable
RMS	Root Mean Square
RSDD	Ripetizione Segnali Discontinua Digitale; Italian ATP system
S	Used for indicating a paragraph that states a safety requirement
STM	Specific Transmission Module
TOR	Top Of Rail

2.3 Definitions

In general, the definitions of UNISIG SUBSET-023 apply. Additionally, the following list of definition applies within this specification:

Term	Definition
Antenna Reference Marks	These indicate the electrical centre of the Antenna Unit.
Antenna Unit	The On-board spot transmission unit, with the main functions to transmit signals to and/or receive signals from the Balise through the air gap.
ASK 700 Balise Transmission System	A spot transmission system for transmission between the wayside Serial (Type B) or Parallel Balise (Type A) and the On-board ATP equipment.
ASK 900 Balise Transmission System	A spot transmission system for transmission between the wayside Serial Balise (Type B) and the On-board ATP equipment.
Balise	A wayside Transmission Unit that uses the Magnetic Transponder Technology. Its main function is to transmit and/or receive signals through the air gap. The Balise is a single device mounted on the track, which communicates with a train passing over it.
Balise Group	One or more Balises that on a higher system level together create a quantity of information related to the location reference in the track, the direction of validity of data, and train protection information. This is the location in the track where spot transmission occurs.
Balise Reference Marks	Physical marks on the Balise to be used as references for measurements at installation and manufacturing. These correspond to a position 10 mm below the nominal centre of symmetry of the Balise radiation pattern (i.e., 10 mm below the nominal electrical centre of the Balise).
Balise Transmission Module (BTM)	An On-board module that processes Up-link signals and telegrams. It interfaces the On-board ERTMS/ETCS Kernel and the Antenna Unit.
Compatibility	Compatibility between two systems means that they can coexist under defined conditions without interfering with each other as to specified functions.
Contact Distance	The distance that is needed to ensure transmission from the Balise with the specified quality. The contact distance is dependent on the specific lateral displacement and mounting height.
Contact Length	The Contact Length of a lobe is the distance between the begin and the end of the lobe as defined by the Lobe Begin and Lobe End criteria. The Contact Length of a Balise is the distance between the first Lobe Begin and the last Lobe End of a certain Balise.
Contact Volume	The volume constituted by the Contact Distances for all lateral displacements and mounting heights of the antenna where transmission from the Balise is guaranteed with the specified quality.
Contact Zone	The zone above the Balise where the transmission is intended to take place, and where the highest requirements on field conformity of the magnetic field with the reference field apply for the Balise.
Cross-talk	When a telegram is read from a Balise that should not be read, e.g., a Balise on another track.

Term	Definition
Cross-talk protected zone	The zone in the vicinity of the Balise where transmission is not intended to take place.
Cross-talk Position	All the positions of the antenna relative to the Balise where transmission is not intended to take place.
Ebicab 700 Transmission System	A Spot Transmission System for transmission between the Parallel Balise, Serial Balise, and/or Opto Balise, and the On-board ATP equipment. It consists of Balise and On-board Equipment, and may also include the Encoder.
Ebicab 900 Transmission System	A spot Transmission System for transmission between the wayside Serial Balise and the On-board ATP equipment. It consists of Balise and On-board Equipment, and may also include the Encoder.
Electrical Centre of the Balise	The nominal centre of symmetry of the Balise radiation pattern (10 mm above the X-Y plane for the Balise Reference Marks). See also the term for Balise Reference Mark.
Eurobalise	A Eurobalise is a Balise that fulfils Ref. [1].
Grey Balise	A Balise that fulfils the applicable parts of the Interface 'G' specification.
Interface 'G'	This is the functional air gap interface between the wayside ASK Balise and the On-board Transmission Equipment. Interface 'G' can be subdivided in interfaces for the Up-link data ('G1'), and the powering of the Balise ('G4'). Interface 'G' comprises six specific air gap interfaces (Interface 'G _A ', Interface 'G _B ', Interface 'G _C ', Interface 'G _D ', and Interface 'G _E ').
Interface 'G _A '	This is the specific interface between the Balise Type A and the On-board Transmission Equipment of the ASK Balise Transmission System.
Interface 'G _B '	This is the specific interface between the Balise Type B and the On-board Transmission Equipment of the ASK Balise Transmission System.
Interface 'G _C '	This is the specific interface between the Balise Type C and the On-board Transmission Equipment of the ASK Balise Transmission System.
Interface 'G _D '	This is the specific interface between the Balise Type D and the On-board Transmission Equipment of the ASK Balise Transmission System.
Interface 'G _E '	This is the specific interface between the Balise Type E and the On-board Transmission Equipment of the ASK Balise Transmission System.
Interoperability	Interoperability between two systems means that they can operate mutually at a specified time and place as to specified function.
Lobe	Spatial envelope of Signal Strength received from a Balise.
Magnetic Transponder Technology	A method that uses magnetic coupling in the air gap between a transmitter and a receiver for conveying data. In the Transmission System context, it considers systems using the 27 MHz band for Tele-powering and the 4.5 MHz band for Up-link transmission. The magnetic field is mainly vertical, and the transponder is located in the centre of the track.

Term	Definition
Mini Balise	A Balise that fulfils the applicable parts of the Interface 'G' specification.
Non-toggling signal	50 kHz modulation of the Tele-powering signal, where each modulation pulse has the same length. Characteristic of the modulation used in the older KER ATP systems. A compatible Eurobalise shall be silent when receiving a Tele-powering signal with this type of modulation.
On-board ATP	Consists of an On-board computer, driver's interfaces and train interface functions. It communicates with the On-board Balise Sub-system via the On-board ATP bus.
On-board Transmission Equipment	Consists of Antenna Unit(s) (for Magnetic Transponder Technology), and Balise Transmission Module(s). It functionally matches the air gap interface and the On-board ERTMS/ETCS Kernel.
On-board Equipment	Consists of On-board ATP, and the combination of the On-board Transmission Equipment and the KER STM.
Opto Balise	A Balise that fulfils the applicable parts of the Interface 'G' specification.
Parallel Balise	A Balise that fulfils the applicable parts of the Interface 'G' specification.
Pitch	An angular deviation where the axis of rotation coincides with the Y-axis.
Reference Mark	Physical marks on the Balise and the Antenna Unit to be used as references for measurements at installation and manufacturing.
Reliability Cross-talk	Disturbing effect on the transmission of data such that correct transmission is unattainable.
Safety	Freedom from unacceptable levels of risk.
Safety Critical	Carries direct responsibility for safety.
Safety Cross-talk	The acceptance of unwanted signals and data, interpreted as valid, by an unintended receiver.
Serial Balise	A Balise that fulfils the applicable parts of the Interface 'G' specification.
Shall	The word implies a mandatory requirement.
Should	The word implies a highly desirable requirement.
Side lobe Zone	The zone relative to the Balise outside the Contact Zone where transmission may take place and where field conformity with the reference field is defined for the Balise.
Specific Transmission Module (STM)	An On-board module that processes Up-link signals and telegrams used by a specific ATP system.
Telegram	A Telegram contains one header and an identified and coherent set of packets. There are several types of Telegrams.
Tele-powering	The method used for powering a Balise from an Antenna Unit through the air gap.
Tele-powering signal	A signal transmitted by the On-board system that activates the Balise upon passage.
Tilt	An angular deviation where the axis of rotation coincides with the X-axis.

Term	Definition
Toggleing Tele-powering Signal	50 kHz modulation of the Tele-powering signal, where every other modulation pulse is longer. Characteristic of the modulation used in a BTM in interoperable mode. A compatible Eurobalise shall answer with a normal FSK signal when receiving a Tele-powering signal with this type of modulation.
Up-link	All functions that are needed in the Transmission System to constitute the communication from the Signal Matching Function to the On-board ERTMS/ETCS Kernel.
Up-link Telegram	This is a Telegram used for Up-link communication, including one User Bit categorising the telegram as valid for Up-link application.
Valid Telegram	A Balise Telegram containing correctly checked information received from the Balise.
Wayside Balise Equipment	Consists of Balise(s) and Encoder(s). It functionally matches the air-gap interface and the Signal matching function.
Yaw	An angular deviation where the axis of rotation coincides with the Z-axis.

2.4 Reference Positioning System

2.4.1 General

The Balise and the antenna unit shall have reference marks, which shall be used to define the exact position of the Balise and antenna unit respectively. The reference marks shall be physical marks on the equipment or described by the manufacturer of the equipment.

The Balise and the antenna unit installation requirements are defined related to three different reference axes, X_r , Y_r , and Z_r . These installation reference axes are related to the rails.

Tilt, pitch, and yaw are defined related to a set of rotation axes defined relative to respective object. The antenna unit rotation axes are related to the reference marks of the antenna unit. The rotation axes of the different Balises are related to the reference marks of the corresponding Balise.

2.4.2 Reference Marks

The reference marks of the Balise and the antenna unit are defining three reference axes X_{balise} , Y_{balise} , Z_{balise} respectively X_{AU} , Y_{AU} , Z_{AU} .

The reference marks are related to the electrical centre of the Balise (see also section 4.2 on page 32).

The defined reference axes can be seen in Figure 3.

The Balise reference marks for the X_{balise} and Y_{balise} axes shall be represented by the centres of its four sides. The Balise reference mark for the Z_{balise} -axis shall be represented by the lower edge of the bottom main mounting plane.

The manufacturer of the antenna unit shall specify the installation position related to the reference marks.

The lower edge of the antenna unit shall be used as height reference mark for the Z_{AU} -axis.

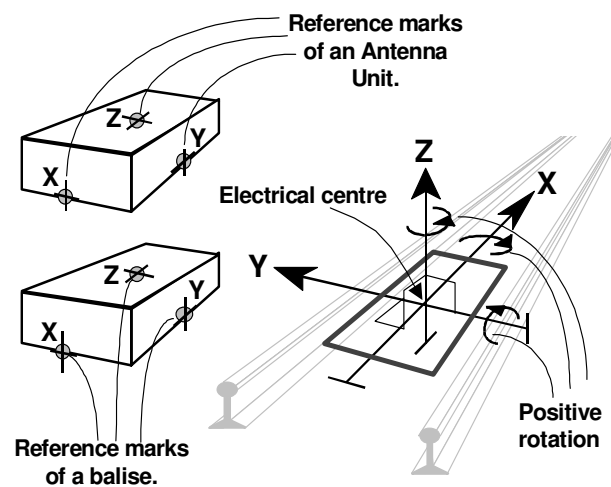

Figure 3: Reference axes

2.4.3 Rotation Axes

To describe the angular deviations from the normal directions, three rotations, with the corresponding rotation axes, are defined for the antenna unit and the Balise respectively.

The antenna unit rotation axes are defined as:

- **X_{AU}-axis** An axis through the X reference marks on the antenna unit.
- **Y_{AU}-axis** An axis through the Y reference marks on the antenna unit.
- **Z_{AU}-axis** An axis through the Z reference mark on the antenna unit, directed upwards, at right angles with the X-and Y-axes.

The defined antenna unit rotation axes can be seen in Figure 3.

The Balise rotation axes are defined as:

- **X_{balise}-axis** An axis through the X reference marks on the Balise.
- **Y_{balise}-axis** An axis through the Y reference marks on the Balise.
- **Z_{balise}-axis** An axis through the Z reference mark on the Balise, directed upwards, at right angles with the X-and Y-axes.

The three rotations, for the antenna unit and the Balise respectively, are defined as:

- **Tilt** An angular deviation where the axis of rotation coincides with the X_{AU}-axis respective the X_{balise}-axis.
- **Pitch** An angular deviation where the axis of rotation coincides with the Y_{AU}-axis respective the Y_{balise}-axis.
- **Yaw** An angular deviation where the axis of rotation coincides with the Z_{AU}-axis respective the Z_{balise}-axis.

To be able to exactly describe the angular deviation related to these axes, the rotation operations shall be carried out in a specific sequence starting from no angular deviation relative to the installation reference axes: yaw, pitch and tilt.

The opposite order of rotation operations shall be used to align an object with the installation reference axes: tilt, pitch and yaw.

The three defined rotations are illustrated in Figure 4.

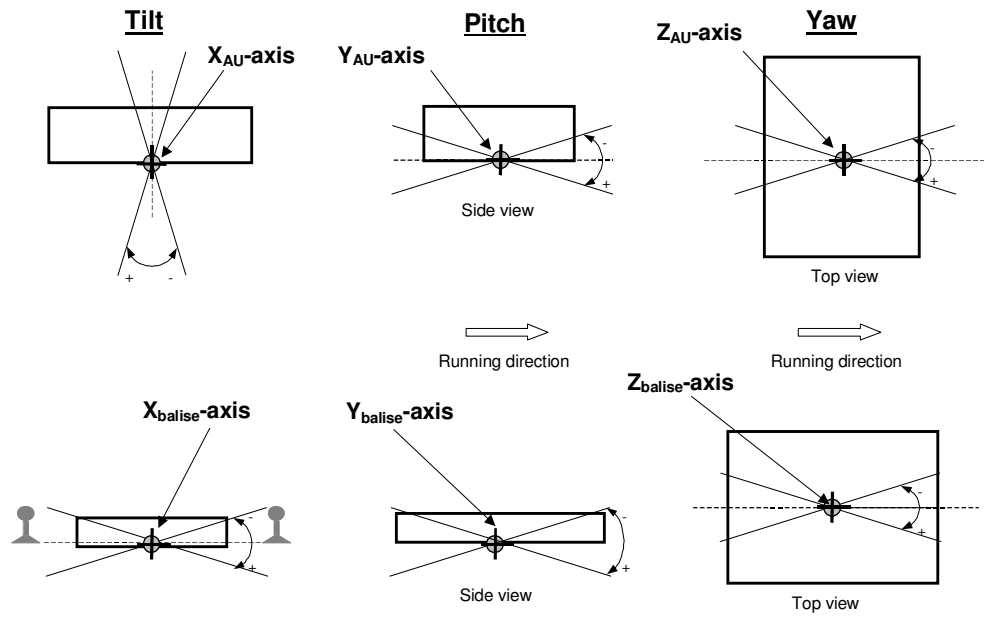

Figure 4: Antenna unit and Balise, rotation axes and the three defined rotations

2.4.4 Reference Axes, Installation Requirements

The installation requirements use a co-ordinate system defined by three reference axes related to the rails.

The antenna unit mounting requirements are specified in Annex F on page 76. These requirements are defined as the position of the antenna unit reference marks related to the reference axes defined below.

The Balise mounting requirements are specified in Annex H on page 80. These requirements are defined as the position of the Balise reference marks related to the reference axes defined below.

The installation reference axes used in the installation requirements are defined as:

- **X_r-axis** An axis in parallel with the rails, and which is in level with the top of rails.
- **Y_r-axis** An axis at right angles across the rails, and which is in level with the top of rails.
- **Z_r-axis** An axis directed upwards, at right angles with the X- and Y-axes.

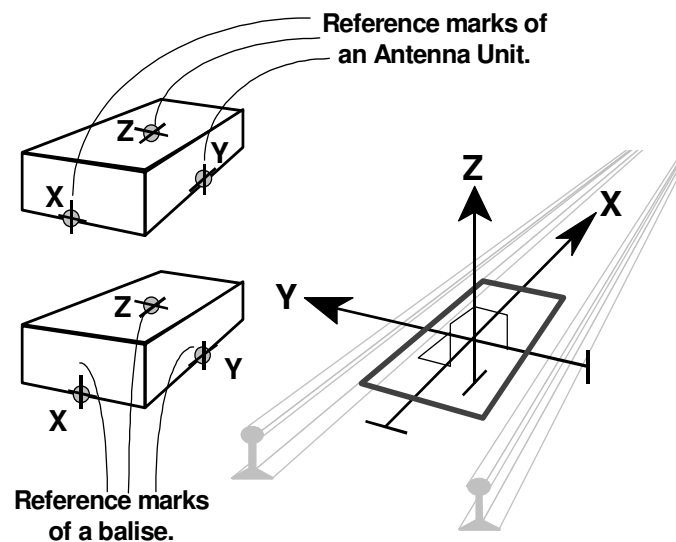

Figure 5: Installation reference axes

The origin of co-ordinates of the co-ordinate system is defined as the top of rail for the Z_r-axis, and as the centre axis of the track for the Y_r-axis. The centre axis of the track is located half the distance between the web of the rails.¹

The installation reference axes can be seen in Figure 5.

Note that the reference marks of the Balises correspond to a point 10 mm below the electrical centre of the Balise.

Whenever the height of the Balise is referred to herein, and the reference is the X_{balise} and Y_{balise} axes, the co-ordinates for the X reference marks and Y reference marks shall be averaged.

¹ There is no need to define the origin of co-ordinates for the X_r-axis.

2.4.5 Influence from Rail Wear

The influence from lateral rail wear shall be considered in the dynamic displacement of the antenna unit.

The vertical rail wear shall be considered in the dynamic displacement of the Balise. See Annex H on page 80.

2.5 Definition of Test Tolerances

The requirements in this specification do not involve the error of the test equipment that is used in the test process, unless this is expressly written. This means that a maximum limit value shall be decreased and a minimum limit value shall be increased with the applicable equipment error during test.

3 Physical Transmission

3.1 Tele-powering (G4) Physical Transmission

3.1.1 Transmission Medium

The On-board antenna unit shall provide power to the wayside Up-link Balises by generating a magnetic field. This field shall be produced in a transmit loop of the antenna unit, and induce a voltage in a reception loop of the Balise. The induced voltage in the Balise shall be based mainly on the vertical component of the magnetic field that flows through the Balise loop.

The definition of Balise size is related to the reference area. See section 4.2 on page 32. The field distribution from the antenna unit shall be such that the Balise is powered in the contact volume for the antenna unit.

3.1.2 Mechanical Data

The requirements on the installation of the antenna unit and the Balise for fulfilling the physical Up-link transmission are stated in chapter 4 on page 32.

3.1.3 Tele-powering Electrical Data

3.1.3.1 General

S The Tele-powering magnetic field shall be produced at a frequency of 27.095 MHz with a tolerance of ± 5 kHz. Existing On-board Transmission Equipment using the frequency 27.115 MHz, ± 5 kHz does not need to change the frequency.

The Tele-powering signal is for both frequencies (27.095 MHz and 27.115 MHz) pulse width modulated by a 50 kHz synchronisation signal. Depending on the On-board Transmission Equipment being used, the modulation signal can either be “togglng” or “non-togglng”.

The field strength of the Tele-powering signal is defined as the RMS value over many modulation periods of the modulated signal (togglng and non-togglng).

The overall requirements on field distribution, contact zone and, cross-talk protection are stated in section 4.3 on page 33.

3.1.3.2 Non-toggling Signal

The following applies to the non-toggling Tele-powering signal (refer to Figure 6):

- Amplitude modulation is at 50 kHz \pm 200 ppm.
- The falling edge of the modulation envelope is constant in phase, with less than \pm 0.1 μ s jitter.
- The fall time of the falling edge of the modulation envelope from 90 % to 50 % of the actual modulation depth, ' t_f ' is between 0.2 μ s and 1.0 μ s according to Figure 6.
- The modulation depth, ' $(a-b)/a$ ', is 100 %, +0/-50 %.
- The pulse width, ' t ', is defined at 50 % of the actual modulation depth, ' $c = (a+b)/2$ '.
- The pulse width, ' t ', is between 2.0 μ s and 3.5 μ s.
- Within the defined limits of ' t ', the maximum jitter of the pulse width is less than \pm 0.1 μ s.
- The overshoot, ' $(d-a)/a$ ', does not exceed 10 %.
- After the time ' t_{stab} ' \leq 7 μ s the amplitude ' a ' does not vary more than \pm 0.5 %.

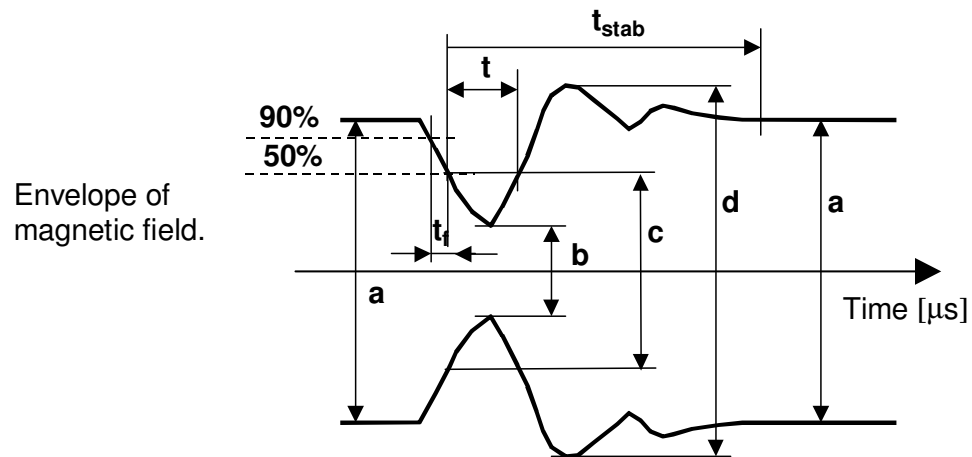

Figure 6: AM pulse parameters for the Tele-powering signal

This section is subject to considerations until further verified.

3.1.3.3 Toggling Signal

The Balise is able to accept, and is able to respond with its telegram to a “toggling” Tele-powering signal (received from an interoperable Eurobalise On-board Transmission Equipment). See section 5.5 on page 54.

The toggling Tele-powering signal is defined in UNISIG SUBSET-036.

3.1.3.4 Compatibility Requirements

The Balise does not respond to a continuous wave (CW) Tele-powering signal except for a short time. The level of unintended signal modulation of the Tele-powering CW carrier is defined as the carrier to noise ratio.

The carrier to noise ratio shall be less than -110 dBc/Hz at a frequency offset of between 10 kHz and 1 MHz.

3.2 Up-link (G1) Physical Transmission

3.2.1 Transmission Medium

The wayside Balise shall generate a magnetic field that shall be picked up by the On-board antenna unit. This magnetic field shall be produced in a transmit loop of the Balise, and shall induce a voltage in a horizontal reception loop of the antenna unit. The antenna unit shall have a built-in, mainly horizontal shield above the reception loop. The data rate shall be 50 kbit/s, synchronised to the Tele-powering synchronisation signal as defined in section 3.1.3, page 27.

3.2.2 Mechanical Data

The requirements on the installation of the antenna unit and the Balise for fulfilling the physical Up-link transmission are stated in chapter 4 on page 32.

3.2.3 Up-link Electrical Data

The magnetic field is produced by pulses of nominally 4.5 MHz that shall be used for amplitude shift keying (ASK) of the Up-link data. The amplitude sent from the Balise represents the logical serial data signal. Low or zero amplitude during the time the bit represents a logical '1', and a higher amplitude within defined limits represents a logical '0'.

The following applies to the Up-link pulse representing a logical '0' (the on key pulse) during the specified debris conditions. See also Annex G, on page 77.

The carrier frequency of the pulse is 4.5 MHz, +200/-500 kHz.

The envelope of the pulse is approximately exponentially decreasing. The time from 90 % to 45 % of amplitude is nominally t_{50} , with the limits t_{50_MAX} and t_{50_MIN} . See Figure 7 on page 31.

- $t_{50} = 3.8 \mu\text{s}$
- $t_{50_MAX} = 5.0 \mu\text{s}$
- $t_{50_MIN} = 2.0 \mu\text{s}$

S The time $t_{pudelay}$ is defined as the delay from a specific trigger level of the falling modulation envelope of the Tele-powering signal to the Up-link on edge, $t_{pudelay}$. See Figure 7 on page 31. The value of $t_{pudelay}$ and the specific trigger level for the Balises are specified in Annex A through Annex E respectively.

The allowed amplitude jitter between "0-bit" pulses is ± 1 dB.

The Balise Up-link logical 0 bit signal level is defined as the mean value of the momentary RMS value counted during 10 μs from the start of the on key pulse (when the rising edge of the Up-link envelope passes 45 %) according to Figure 7 on page 31.

The Balise Up-link logical 1 bit signal level is defined as the mean value of the momentary RMS value counted during 10 μs from the falling edge of the Tele-powering magnetic field passing the trigger according to Figure 7 on page 31. Only the logical 0 bit signal is shown in the figure.

Momentary RMS is defined over one period of the nominal frequency of the signal itself.

The mean Up-link signal level is defined as the mean value of the Balise Up-link logical 0 bit signal level evaluated over many 0 bits. For steady state over many telegrams, and for dynamic situations, shorter time may be used down to 10 zero bits dependent on the slope of the changing conditions.

The Balise Up-link logical 1 bit signal level is at least 26 dB lower than the mean Up-link signal level.

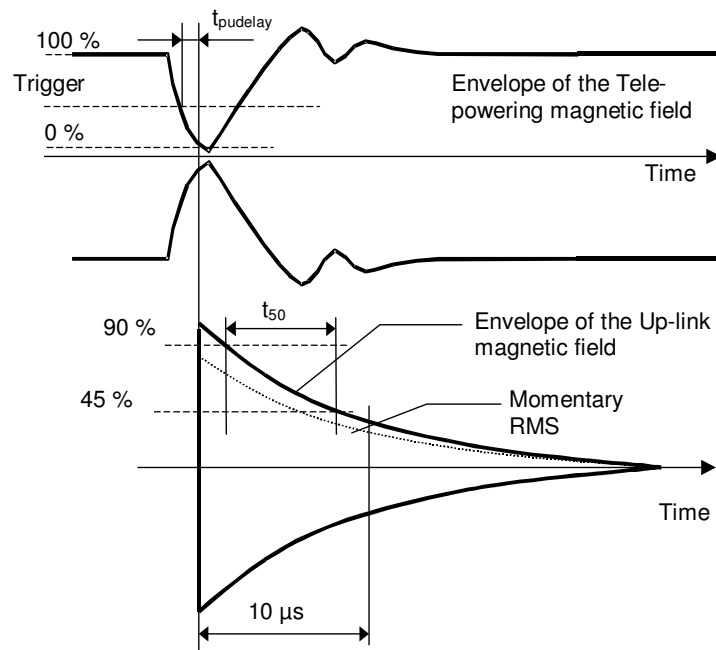

Figure 7: Timing requirements and definition of signal strength of the Up-link magnetic field

The requirements on field distribution, contact zone, and cross-talk protection for the Up-link transmission are stated in section 4.3 on page 33.

4 Physical Interaction and Environment

4.1 Antenna Unit and Balise Interaction

The operational requirements on the transmission towards the Balise depend on the design of the antenna unit, the design of the Balise, and the requirements in this document.

This air gap specification neither restricts sizes for the antenna units, nor the performance of the antenna unit regarding maximum speed and mounting distances. However, please observe implicit antenna requirements related to the side lobe filtering algorithms defined in UNISIG SUBSET-101.

To make interoperability possible, the Balise position relative to the track (see Annex H on page 80), and the size of the active reference area of the Balises shall be the same for all manufacturers, in accordance with this specification and the related application. See section 4.2.

The influence of metal masses like metal structures underneath the Balise may influence the flux from an antenna unit into the reference area of the Balise, and influence the field from the reference area to an antenna unit. Therefore, and due to the requirement for interoperability, the position of the reference area relative to metal masses shall also be the same for all manufacturers.

It shall be possible to simulate the On-board Transmission Equipment using a portable Balise tester. The interface between the Balise tester and the Balise may be different from the Interface 'G'.

4.2 Balise Reference Area

The operational requirements and the output field strength of the antenna loops of the Balise are final, i.e., they cannot be changed in future implementations and designs of the system.

In general, the Balise has the reference area 358 mm × 488 mm for the measurements of field strength from the antenna unit as well as of the output field strength from the Balise. The only exception is the Balise Type C, which has the reference area 200 mm × 390 mm.

The reference area shall be centred on the Z_{balise} -axis, and be in a level 10 mm above the X_{balise} and Y_{balise} axes of a Balise. The longer side of the reference loop is corresponding to the X_{balise} direction of the Balise.

The output field strength from a Balise shall be defined as the current I_u that encircles the border of the reference area in a position 10 mm above the X_{balise} and Y_{balise} axes of the Balise as defined in section 2.4 on page 22.

The output signal from the antenna unit in any position relative to the reference area shall be defined as the total flux Φ_d through the reference area in a position 10 mm above the X_{balise} and Y_{balise} axes of the Balise. The field from the antenna unit does not need to be homogeneous in the vicinity of the antenna unit.

A reference loop should be used for measuring the flux from an antenna unit and for measuring the field strength from a Balise. The reference loop used for test purpose shall be conform to the definitions of the reference area.

4.3 Air gap Transmission Requirements

4.3.1 General

The field distribution from the antenna unit shall be such that the Balise gets enough power to be able to provide an output signal forming the contact volume for the antenna unit. This also relates to the specific Balise and the specific conditions.

The distance in the X-direction above the Balise where reliable transmission shall take place shall be longer than the minimum required contact distance, in which the properties of the code and the dynamic start-up times for the Balise and the On-board Transmission Equipment are taken into account. See section 4.3.3.2 on page 37.

The field strength from the antenna unit shall be defined as the total flux into a Balise reference area placed in any position relative to the antenna unit. The total flux through this area can be measured by a calibrated reference loop, according to section 4.2 on page 32. The input signal to a Balise, for different positions relative to the antenna unit, shall be based on this flux.

4.3.2 Field Conformity

4.3.2.1 General

The vertical component of the field from the Up-link Balise, and the Tele-powering field through the Balise, shall conform with the respective reference field.

The Up-link reference field is the vertical component in free space from a constant current that encircles the border of the reference area. See section 4.2 on page 32.

The conformity of the Tele-powering signal to the Balise (the input signal to the Balise with the field received in the reference area) shall be within the same tolerances as for the Up-link signal. For testing the conformity of the Tele-powering, reciprocity between the field probe and the reference area, and between the field probe and the Balise, respectively, should be used.

For the conformity of the field forms, three zones are defined. The contact zone, the side lobe zone, and the cross-talk protected zone.

The field from the Balise and the flux through the Balise may deviate from the form of the field in free space due to debris and to the proximity to conductive material. The influence of such deviations of the field form shall be considered in the antenna unit design.

Debris and the proximity to conductive material may influence the efficiency of the Balise itself. Such influence shall be within the specified limits for the performance of the Balise.

The allowable layers of debris on top of the Balise are specified in section 4.7 on page 51. The allowable layers of debris on the antenna unit shall be specified by the antenna unit manufacturer.

4.3.2.2 Contact Zone

The contact zone is the zone above a Balise where the transmission is intended to take place. The contact zone is defined as the volume within the 16 corners of Figure 8. The position of the reference area is related to the electrical centre of the Balise and the direction co-ordinates, as defined in Figure 3 on page 22. See section 2.4.4 on page 25 for the relation between the reference marks and the electrical centre.

In Figure 8 below, the values are related to the electrical centre of the Balise (values in mm).

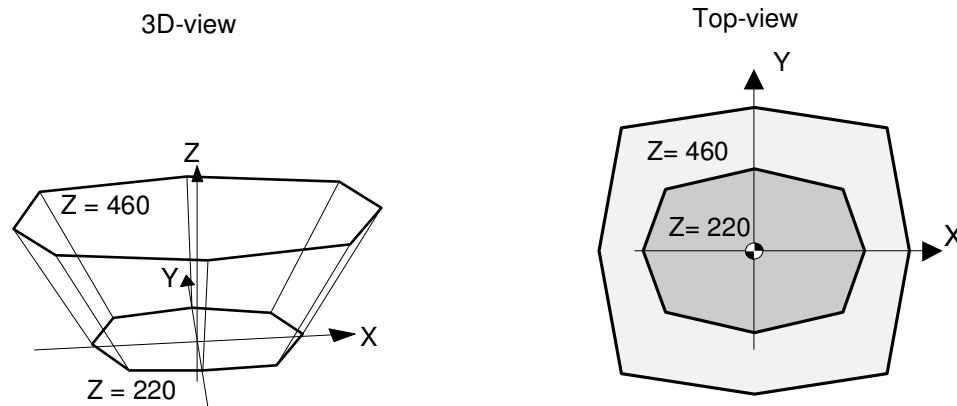

Figure 8: The volume of the contact zone for the reference area

The volume of the contact zone for a reference area parallel to the X-axis (values in mm related to the electrical centre of the Balise):				
Height	Balise Type			
	General		Balise Type C	
Z=220 min	X = 0 X = ±250 X = ±200	Y = ±200 Y = 0 Y = ±150	X = 0 X = ±200 X = ±170	Y = ±180 Y = 0 Y = ±150
Z= 460 max	X = 0 X = ±350 X = ±300	Y = ±350 Y = 0 Y = ±300	N/A	N/A
Z= 430 max	N/A	N/A	X = 0 X = ±200 X = ±170	Y = ±180 Y = 0 Y = ±180

Table 3: The volume of the contact zone for a reference area

Within the contact zone the conformity requirement is that the difference between a field generated by a Balise and the reference field shall be within ± 1.5 dB. See Figure 9.

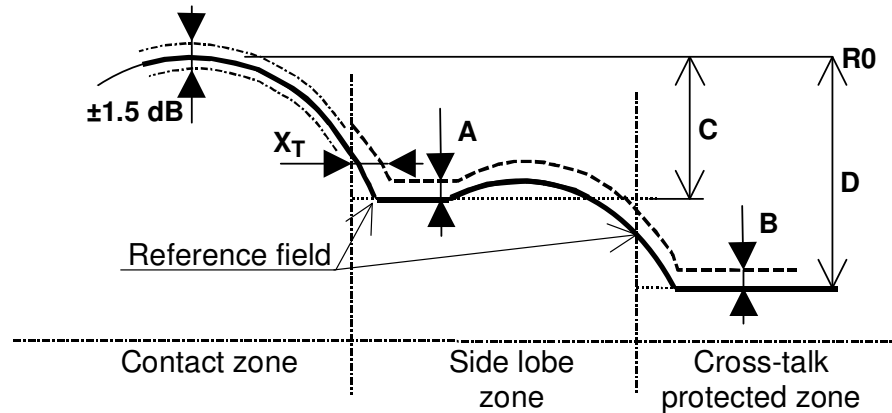

Figure 9: Reference field and limits

4.3.2.3 Side lobe Zone

The side lobe zone is the zone that is between the contact zone and the cross-talk protected zone. For conformity the following co-ordinates apply:

- $-1300 \text{ mm} < X < +1300 \text{ mm}$
- $-1400 \text{ mm} < Y < +1400 \text{ mm}$
- $+220 \text{ mm} < Z < +460 \text{ mm}$

In the part of the side lobe zone closest to the contact zone (the notch part), the reference field is limited to be no more than C dB lower than relative to the highest field strength in the contact zone at level Z = 220 mm (R0).

In the side lobe zone the reference field is also limited to be no lower than the values given by the reference field translated $+x_T$ cm or $-x_T$ cm along the X axis, and translated $+y_T$ cm or $-y_T$ cm along the Y axis.

The conformity requirement for the side lobe zone is that the difference between a field generated by a Balise and the reference field shall be between +A dB and $-\infty$ dB. See Figure 9.

The tolerances and limits for the side lobe zone are:

- A = 5 dB
- C = 35 dB
- $x_T = 5 \text{ cm}$
- $y_T = 5 \text{ cm}$

4.3.2.4 Cross-talk Protected Zone

In the cross-talk protected zone, the reference field is limited to be no more than D dB lower than the highest field strength in the contact zone at level Z = 220 mm (R0).

The conformity requirement for the cross-talk protected zone is that the difference between a field generated by a Balise and the reference field shall be between +B dB and $-\infty$ dB. See Figure 9 on page 35. Conformity in Tele-powering does not apply in the cross-talk protected zone.

The tolerances and limits for the cross-talk protected zone are:

- B = 5 dB
- D = 60 dB

4.3.3 Transmission in the Contact Zone

4.3.3.1 Input-to-output Characteristics

The input-to-output characteristics of a Balise are according to Figure 10 below. The influence from debris (see Annex G on page 77) and from approved mounting details (see section 4.5 on page 43) are included.

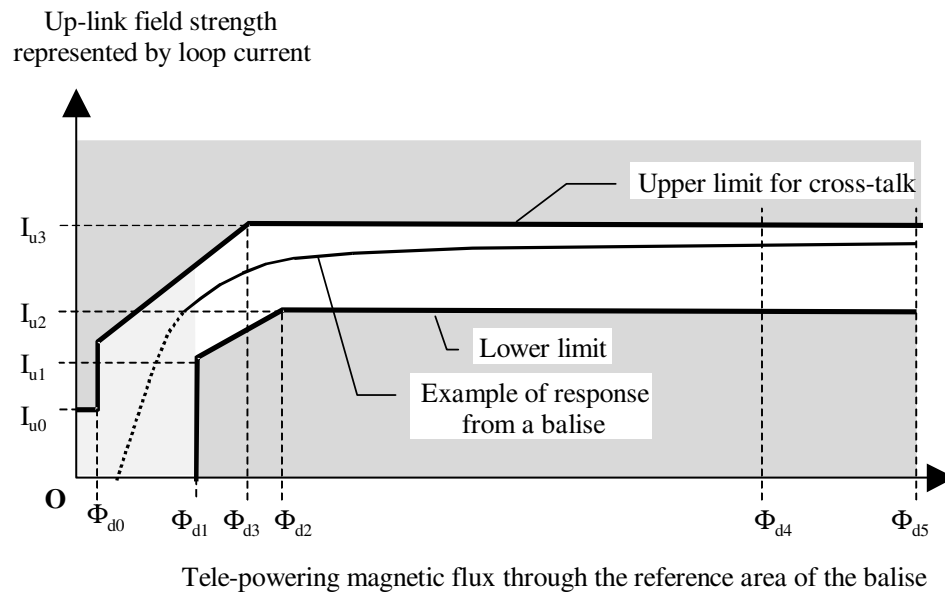

Figure 10: Input-to-output characteristics for a Balise

The Balise Up-link current I_u is the mean Up-link signal level as defined in section 3.2.3 on page 30.

The level of the field strength of the Tele-powering signal is the RMS value of the modulated signal as defined in section 3.1.3 on page 27.

The values of the currents and fluxes in Figure 10 for the Balises are stated in Annex A through Annex E respectively.

When the flux through the reference area of the Balise is below Φ_{d0} , the field strength from the Balise is lower than the field strength represented by a current of I_{u0} that flows in a conductor encircling the border of the reference area.

When the total flux from the antenna unit through the defined reference area of the Balise exceeds Φ_{d1} , the Balise has started to operate in the appropriate transmission mode (the mode transfer is described in section 5.5 on page 54). Further, the field strength from the Balise is higher than the field strength represented by a current of I_{u1} to I_{u2} (described by the dotted input to output characteristic linear diagram in Figure 10) that flows in a conductor encircling the border of the reference area.

When the flux from the antenna unit is greater than Φ_{d2} , the field strength from the Balise is higher than the field strength from a current I_{u2} in the encircling conductor.

The field strength of the Balise does not exceed a field strength represented by a current of I_{u0} , I_{u1} , I_{u2} to I_{u3} (described by the solid input to output characteristic linear diagram in Figure 10).

The output signal from the Balise for an input signal lower than Φ_{d1} is regarded to be non-specified. However, the Balise is not allowed to send a false (not intended) telegram.

When the flux from the antenna unit is higher than Φ_{d4} , the proper function of the Balise is not assured other than that the Balise fulfils the impedance requirement (see section 4.3.3.3 on page 40). It is also assured that the field strength is lower than the field represented by a current of I_{u3} that flows in a conductor encircling the border of the reference area.

- S When the flux from the antenna unit is higher than Φ_{d5} , the Balise may be destroyed, or the reliability may be decreased. Thus the antenna unit shall not create a flux that exceeds Φ_{d5} .

4.3.3.2 Contact Volume Requirements

V_{th} is an internal threshold of the On-board Transmission Equipment. To each point around the antenna unit, and any condition, there is a corresponding current I_{uth} around the reference area that corresponds to the threshold V_{th} and at each point a flux Φ_d is transmitted into the reference area.

The output flux Φ_d and the threshold V_{th} may vary during different conditions, and with respect to internal not immediately detected errors in the On-board equipment. The input to output characteristics of the Balise is defined in section 4.3.3.1 on page 36. The contact volume is the sum of all positions in three dimensions where the received signal (with respect to the transmitted flux and input output characteristics) is above the actual signal strength that corresponds to the current I_{uth} around the reference area in that position.

Hereafter, the received field strength into the On-board Transmission Equipment (also mentioned as 'signal level') is said to correspond to the threshold V_{th} when the received field strength is equal to the I_{uth} for that point.

The value of the field strength that corresponds to the current I_{uth} in one specific point relative to the antenna unit depends on the input-to-output characteristics of the Balise and on the design of the antenna unit. The level is fundamental for the cross-talk protection, the fundamental detection of the Balises and for the determination of reliable transmission of data.

- S The combination of the On-board Transmission Equipment and the KER STM shall not deliver any received telegram to the On-board ATP when the received field strength from the Balise is lower than the minimum value of V_{th} .
- S For the entire signal path from the Tele-powering signal to the received Up-link signal field strength, within the specified Balise Detect contact volume for the specific antenna unit and Balise combination, the total attenuation shall be less than the value that gives a signal equal to the maximum value of the field strength threshold V_{th} .

When the Balise is in the contact volume, it is powered by the antenna unit. The combination of the On-board Transmission Equipment and the KER STM shall be able to receive the data from the Balise in the telegram transmission contact volume. It shall take into account the input-to-output characteristics of the Balise (see Figure 10 on page 36), the reception time, and the signal modulation criteria.

Contact distance is the size of the contact volume in the X_r direction. There are two different requirements on contact distance for the antenna unit, the contact distance for safe Balise Detect and the contact distance for reliable transmission of telegrams.

Contact distance for safe Balise Detect:

- S Within the contact volume for Balise Detect, the combination of the On-board Transmission Equipment and the KER STM shall detect a Balise when the field strength from the Balise is higher than V_{th} for a sufficiently long time according to below.
- S For the purpose of Balise Detection, the On-board Transmission Equipment shall guarantee a minimum duration of signal strength exceeding the V_{th} threshold in accordance with Figure 11 below. The figure does not consider speed and position errors.

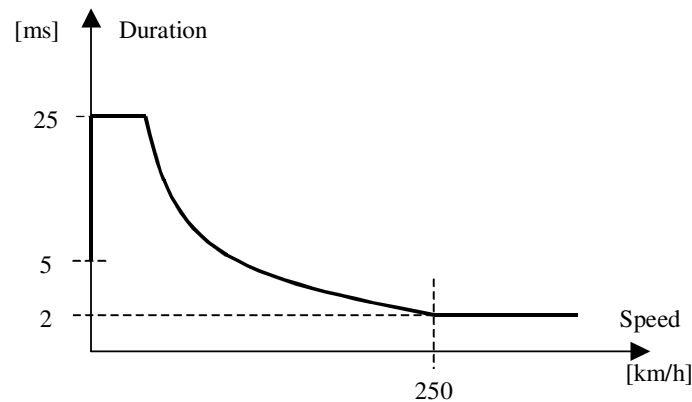
**Figure 11: Minimum Balise Detect Time**

In the speed range between the first break point of the curve (approximately 20 km/h) and 250 km/h, the minimum required duration of signal above the V_{th} threshold is such that the resulting contact length exceeds 139 mm. Above 250 km/h, the minimum required duration is kept constant at 2 ms. Below the first break point of the curve (approximately 20 km/h), the minimum required duration is kept constant at 25 ms. In order to reduce the risk for filtering out Balise Detects in case of failing tachometer functions (thus indicating a speed of 0 km/h), the required duration at the speed 0 km/h is set to 5 ms.

It is the responsibility of the On-board Transmission Equipment to consider the start-up time for the Balise (see section 5.5 on page 54), to handle uncertainties due to signal shape (see section 3.2.3 on page 30), and also consider possible interference due to on-line tests (the actual length applies but is maximum 32 bits for Interface 'K' supervision). The On-board Transmission Equipment is also responsible for aspects on desired availability of the system with respect to the expected external noise that may disturb the transmission, considering the actual contact distances and maximum allowed speed of the system/vehicle.

It is the responsibility of the STM to handle the impact from the specifically used coding strategy.

For availability reasons, it is required that the STM criteria for Balise Detection are as close as possible to the limits defined by Figure 11 (i.e., STM internal margins to the limits shall be minimised).

Contact distance for telegram decoding:

For the purpose of being able to decode the telegram, a minimum number of consecutive error free bits are required. See further chapters J4 on page 85, K4 on page 86, L4 on page 88, and M4 on page 90.

See also requirements on the STM behaviour in Ref. [6] related to checking of data with respect to the coding requirements.

4.3.3.3 Balise Impedance

When the Balise receives a flux Φ_d from the antenna unit, a voltage is induced in the Balise receiver loop.

The Balise loads the induced voltage, which in turn generates a current $I_{\text{reflected}}$ in the receiver loop. This current may, if the distance to the antenna unit is very small (inside the contact zone), influence the antenna unit. This interaction can be expressed as an impedance $Z_{\text{reflected}}$ (the induced voltage $\omega\Phi_d$ divided by the current $I_{\text{reflected}}$).

The limit for the absolute value of the complex impedance of the Balise, $Z_{\text{reflected}}$, is stated in Annex A through Annex E for the respective Balises.

4.3.4 Transmission in the Cross-talk Positions

4.3.4.1 General

- S** The received signal level from the Balise in the cross-talk positions shall be lower than the minimum value of V_{th} (the lowest possible cross-talk threshold level of the receiver), and under the worst case conditions as defined below. V_{th} is defined in section 4.3.3.2 on page 37.

The following circumstances shall be considered for the worst case cross-talk condition:

- The input-to-output characteristics of the Balise, e.g., highest possible efficiency. See Figure 10 on page 36.
- The minimum value of the field strength threshold, V_{th} , of the On-board Transmission Equipment receiver.
- The worst case timing of the Up-link data ($t_{pudelay}$) for the On-board Transmission Equipment. $t_{pudelay}$ is defined in section 3.2.3 on page 30.
- Normal reflections from the body of the vehicle.
- Metal reflectors on the ground.
- The limitations for the installation according to the sections 4.1 on page 32, 4.4 on page 43, and 4.6 on page 50.
- Influence of debris.
- Presence of cables outside the metal free area of the Balise.

The installation requirements for the Balise to protect from safety cross-talk are described in section 4.5, page 43.

4.3.4.2 Intrinsic Cross-talk Protection

The protection from cross-talk is based on both Up-link and Tele-powering properties, but in the case of two antenna units only the Up-link properties of the intrinsic cross-talk protection protects from cross-talk.

The worst case situation for the On-board Transmission Equipment and for the air gap propagation shall be considered as defined in section 4.3.4.1.

- S** Two different cases apply for a Balise positioned in the cross-talk positions defined in Table 4 relative to the antenna unit.

- One or many Balises, one antenna unit

The total attenuation of the Tele-powering and the Up-link signal between the antenna unit and the Balise shall assure that the received Up-link field strength is below the minimum level of V_{th} .

- One or many Balises, two antenna units

A cross-talking Balise may be powered by another vehicle (e.g., highest possible output current I_{u3} , see Figure 10 on page 36). The received signal level from the cross-talking Balise shall be less than the minimum value of V_{th} .

The following cross-talk positions apply for the Balise:

Type of cross-talk	Involved equipment	Cross-talk positions
Lateral (direction Y)	One Balise, one antenna unit.	1.4 m or more between the Balise and the antenna unit (related to the Z reference mark).
Lateral (direction Y)	One or two Balises, two antenna units.	3.0 m or more between the cross-talking Balise and the interfered with antenna unit (related to the Z reference mark).
Longitudinal (direction X)	Two Balises, one antenna unit.	2.3 m or more between two consecutive Balises (related to the Y reference marks).
Longitudinal (direction X)	One Balise, two antenna units.	Depends on the kind of antenna units being combined (manufacturer and system dependent).
Vertical (direction Z)	One Balise, one antenna unit.	4.8 m or more, related to the X_{balise} and Y_{balise} axes.

Table 4: Cross-talk positions specified for the Balise

Other cross-talk conditions:

Object	Requirement
Cables in the track.	Cables shall be outside the protected area according to Figure 12 on page 45, and the installation of cables shall fulfil the requirements stated in section 4.5.7 on page 46.
Metallic reflectors on bridges and in the track.	Metallic objects on the ground shall be outside the protected area for the Balise according to Figure 12 on page 45.

Table 5: Other cross-talk conditions

The cross-talk protection is also handled by different installation requirements for the Balise, see section 4.5 on page 43.

4.4 Procedure Control and Error Handling

4.4.1 Side lobe Filtering

The combination of the On-board Transmission Equipment and the KER STM shall use the lobe where the Antenna unit and the Balise are aligned to each other. This lobe is called the main lobe. Outside this lobe the magnetic flux density through the reference area of the Balise changes direction, and a side lobe is generated by the On-board antenna unit.

If the flux in this side lobe is strong enough to activate the Balise, the Balise may respond with an Up-link signal. Thus one Balise may be interpreted by the combination of the On-board Transmission Equipment and the KER STM as two or several Balises by mistake.

If more than one lobe is received from one Balise, the BTM or STM functionality must ensure that the reception of multiple lobes does not have a negative effect on the output of the STM. The activation of the Balise before or after the main lobe shall not disturb the transmission in the main lobe.

4.4.2 Balise Detect

- S** The level of field strength from the antenna unit that is needed to activate and power the Balise in the contact volume required for Balise detect shall be supervised by the BTM function and/or antenna. If the level is too low, this is an error and shall be detected by the BTM function and/or antenna. If the level of the activation signal is so high that it may generate cross-talk, this error shall be detected by the BTM function and/or antenna. See also section 4.3.3.2 on page 37.
- S** The receiver threshold shall be supervised by the BTM function and/or antenna. If the level is erroneous, this shall be detected by the BTM function and/or antenna. See also section 4.3.3.2 on page 37.
- S** The modulation characteristics of the Tele-powering signal shall be supervised by the BTM function and/or antenna. If being erroneous, this shall be detected by the BTM function and/or antenna. See also section 3.1.3.2 on page 28 and section 3.1.3.3 on page 29.

An alternative to the ability of detecting these errors is that the errors are shown not to be possible to occur.

4.5 Balise Installation Requirements

4.5.1 General

- S** The installation requirements on the Balise described in this chapter shall be fulfilled to protect from safety cross-talk, and to ensure that the combination of the On-board Transmission Equipment and the KER STM is able to detect Balises.

An installation record shall be made for each Balise/Balise Group where it shall be evident that the installation requirements are fulfilled.

In this section the approved installation conditions for the Balise are defined. Installation conditions that are not covered by this specification shall be investigated by the manufacturer of the Balise before approval of the installation.

Balises may not be installed in the presence of inductive loops (e.g., LZB, loop in the TVM system, etc.).

4.5.2 Balise Orientation in Relation to the Rails

The specific installation applications for the specific interfaces are defined in the annexes at the end of this document.

4.5.3 Mounting Distances between Balises

The following general requirements are valid for mounting distances between Balises (see also section 4.3.4.2 on page 41):

Direction	Min. Distance	Application
Longitudinal (direction X)	2.3 m	The distance between two consecutive KER Balises in a track (related to the Y reference marks). Please observe the country specific exception defined in section H3.4.4 on page 83.
Longitudinal (direction X)	2.6 m	The distance between a Eurobalise and a KER Balise (related to the Y reference marks).
Vertical (direction Z)	4.8 m	Distance between two Balises in two different tracks, e.g., two level bridges (related to the X_{balise} and Y_{balise} axes).

Table 6: Mounting distances between Balises

Restrictions on lateral positioning (direction Y) are defined in section 4.3.4.2 on page 41.

4.5.4 Metal Free Volume

A Balise shall be mounted in such a way that metal, except for the approved mounting details (see section 4.5.5, page 46), is avoided in a cubic volume around the Balise, as shown in Figure 12. The limits to the sides and downwards (in the directions X, Y, and Z) refer to the reference marks of the Balise. Upwards, in the Z-direction, the metal free volume shall extend above the Balise limited only by the vertical track clearance.

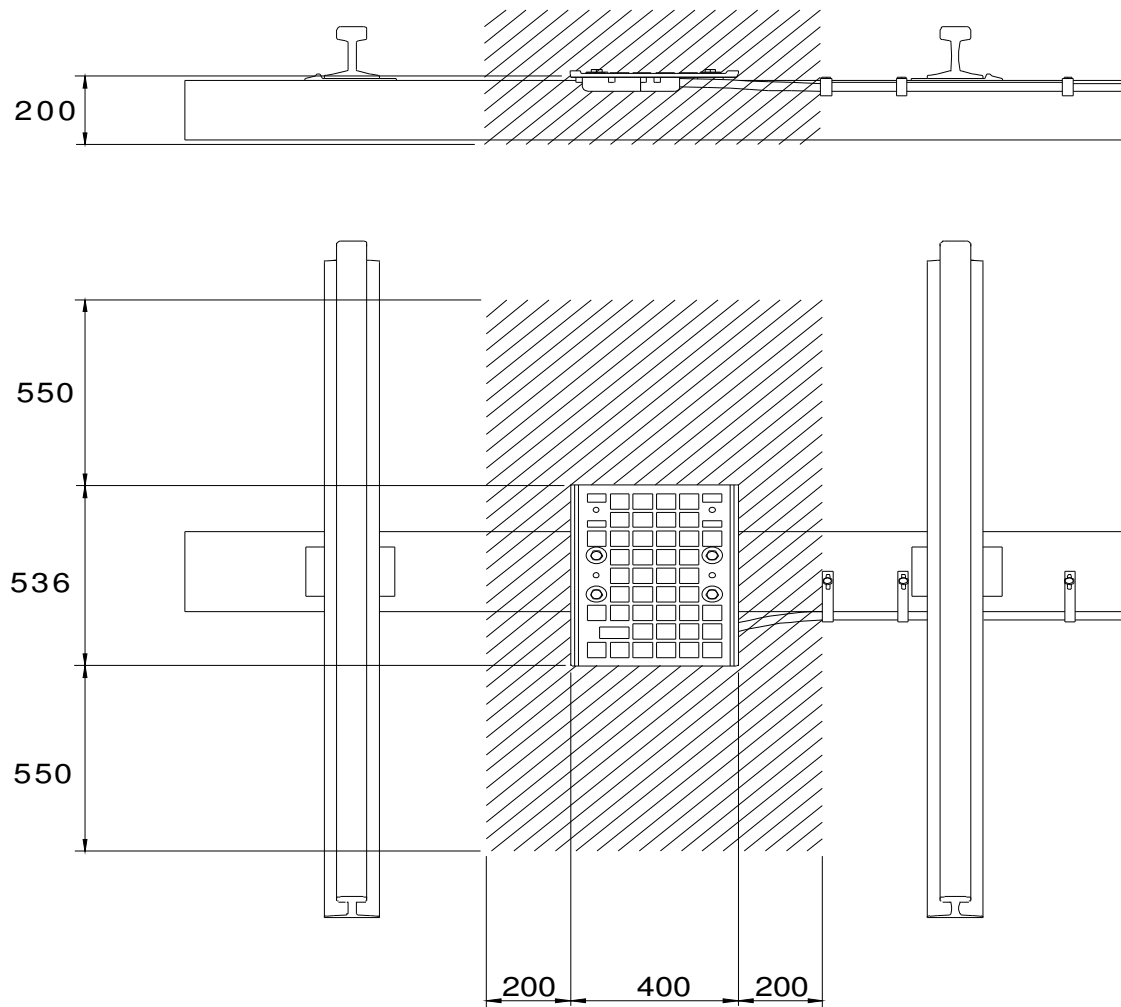

Figure 12: Metal free volume for a Balise

Since a sleeper may contain metal, the method for mounting a Balise must be approved for each type of sleeper.

The influence from concrete and bi-block sleepers shall be allowed for in the overall tolerances for the Balise including the height of the Balise. This means that no compensation of the height shall be needed for these types of sleepers.

4.5.5 Mounting to Sleeper

The size of metallic mounting assemblies shall be restricted when mounting a Balise to sleepers. When viewing the metallic mounting assemblies in the Z-direction, the total area in the X/Y-plane of projection shall not exceed 300 cm².

The mounting assembly and the reinforcement of a sleeper should not create or have the form of conductive loops. If they do, the requirements stated in section 4.5.4 on page 45 apply.

4.5.6 Guard Rails

For ensuring both cross-talk protection and reliable transmission, guard rails in the vicinity of Balises shall be cut, leaving gaps of at least 30 mm. Such a cut (one in each rail) shall be done within ± 100 mm in the X-direction from the Z-reference mark of the Balise.

In the Y-direction, measured from the Z-reference mark of the Balise, the metal free volume for the Balise shall be at least ± 215 mm. See Figure 13.

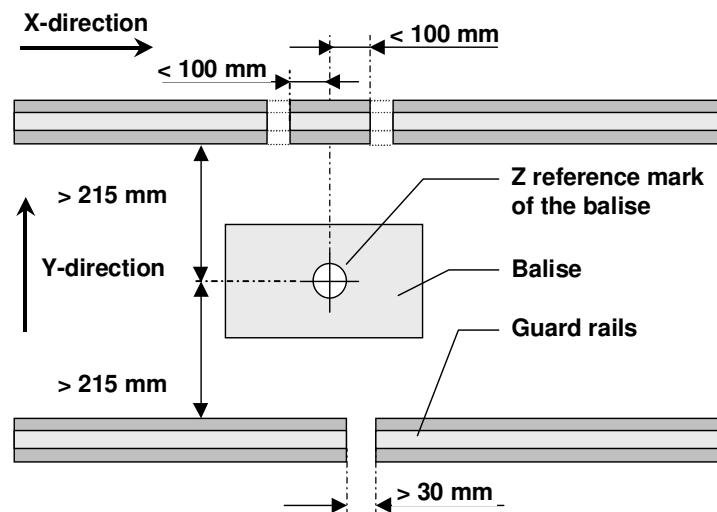

Figure 13: Guard rails in the vicinity of the Balise, only one cut per rail is needed

4.5.7 Interfering Conductive Cables

4.5.7.1 General

To ensure cross-talk protection, there are restrictions in the way cables, or other conductors, can be placed in the proximity of the Balise. The volume above the Balise shall be free from cables and metal material according to section 4.5.4 on page 45.

This section deals with cable related cross-talk, both Up-link and Tele-powering cable related cross-talk. The Up-link cable related cross-talk must be assured by certain installation requirements on the Balise. See section 4.5.7.3 on page 47.

4.5.7.2 Tele-powering Cable Related Cross-talk

The Balise shall be installed in such a way that a current of a certain maximum value being induced in a nearby conductor from a Tele-powering signal does not generate a malfunction of the interfered Balise.

4.5.7.3 Up-link Cable Related Cross-talk

The worst case condition with cables is when a Balise in one track is installed close to a conductor that crosses another track. See Figure 14.

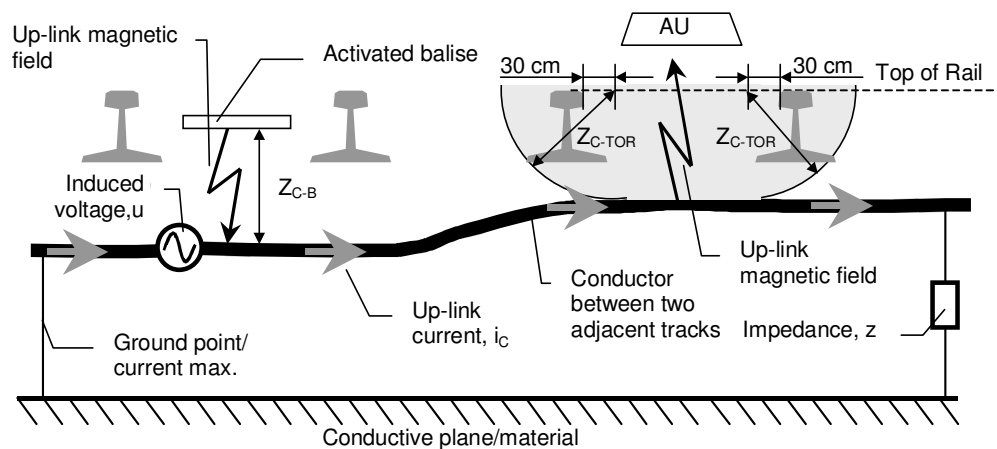

Figure 14: Up-link cable related cross-talk between two adjacent tracks

An induced Up-link voltage, 'u', in a conductor that crosses an adjacent track at a certain distance shall generate an Up-link current, 'i_C', less than 'i_{C_MAX}'. The maximum induced current into the conductor, 'i_{C_MAX}', shall be according to Figure 15.

The Up-link current, 'i_C', depends on the transfer conductance ($g = 1/z$) of the conductor taken into account the characteristics of the conductor itself and the dielectric of the surrounding materials. Two cases for conductors in the track are defined; conductors in normal humid ground and conductors on iron bridges, which represent the normal and the worst case situation for cable related cross-talk.

The following equation applies: $i_C = u \times g < i_{C_MAX}$

The shaded area in Figure 14 defines the allowed distance to the crossing cable. The radius 'Z_{C-TOR}' is dependent on the level of the maximum Up-link current in the conductor, 'i_{C_MAX}'.

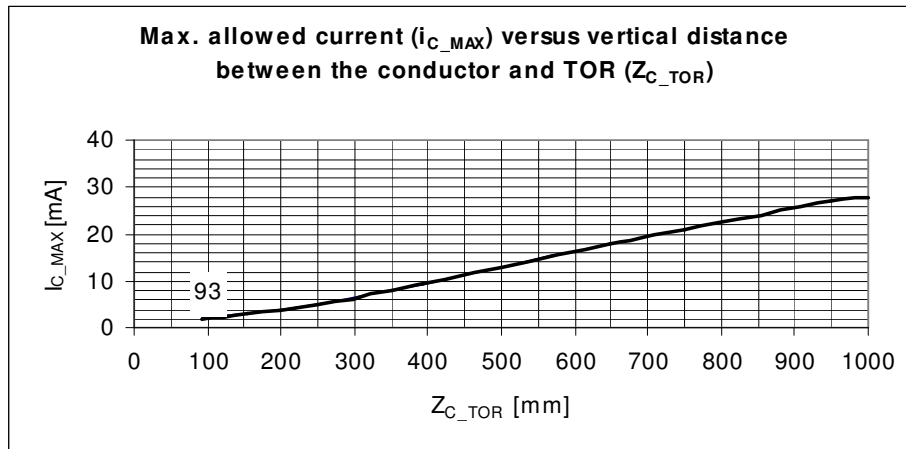

Figure 15: Maximum allowed Up-link current in a conductor caused by induction from a nearby Balise

4.5.7.4 Installation Requirements in the Vicinity to Cables

The Balise shall be installed in such a way that the interaction with conductors is low. The Balise shall be far enough from a conductor to guarantee that the interaction with the conductor does not cause safety cross-talk.

If a conductor is more than 1 m from any edge of the Balise it can be assumed that these requirements are fulfilled.

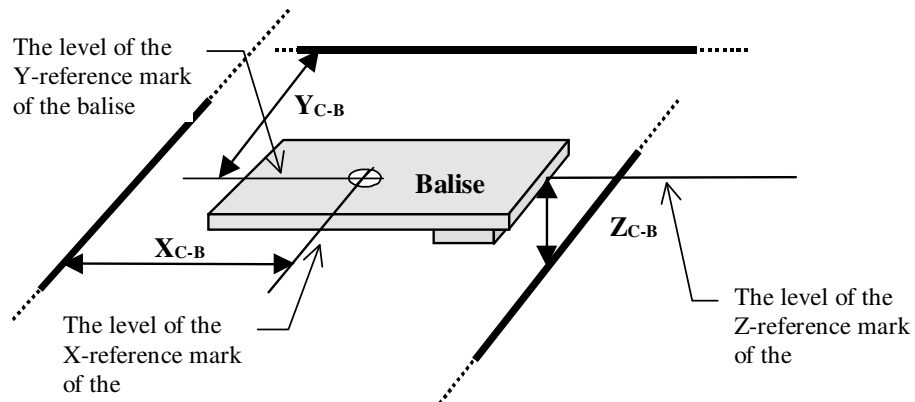

Figure 16: Location of cables/conductors in the proximity of the Balise

When a nearby conductor relative to the Balise also crosses an adjacent track at a distance defined by ' Z_{C_TOR} ', the Balise shall be installed a distance ' D_{C_B} ' from the nearby conductor.

The installation requirements for the two cases shall be according to Figure 17 and Figure 18 respectively.

The type 'iron bridges' (see Figure 18) shall be applied when the metallic cable/conductor is installed less than 1 m to a metallic structure and when the attenuation properties of the surrounding materials are insignificant.

The type 'conductors in the ground' (see Figure 17) shall be applied when the cable/conductor is installed in normal humid ground with significant attenuation.

The distance ' D_{C-B} ' is defined as the distance ' X_{C-B} ' when the conductor is parallel to the Y-axis and defined as the distance ' Y_{C-B} ' when the conductor is parallel to the X-axis. ' X_{C-B} ' and ' Y_{C-B} ' are described in Figure 16 on page 48. The distance ' Z_{C-TOR} ' defines the area to where no conductors are allowed, see Figure 14 on page 47.

Figure 17 below defines the allowed distance, ' D_{C-B} ', between the Balise and a nearby cable that crosses an adjacent track at a distance ' Z_{C-TOR} '. The diagram concerns conductors placed in normal humid ground.

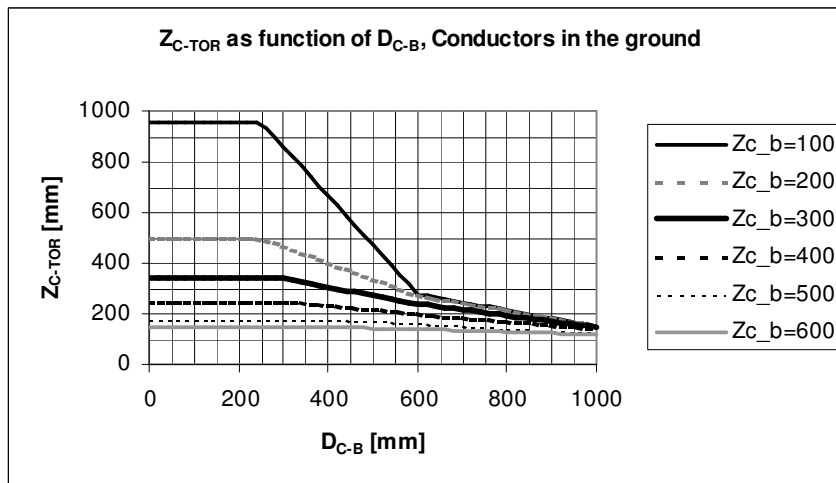

Figure 17: Distance, ' D_{C-B} ', between the Balise and a nearby cable in the ground

Figure 18 below defines the allowed distance, ' D_{C-B} ', between the Balise and a nearby conductor that crosses an adjacent track at a distance ' Z_{C-TOR} '. The diagram concerns conductors on iron bridges.

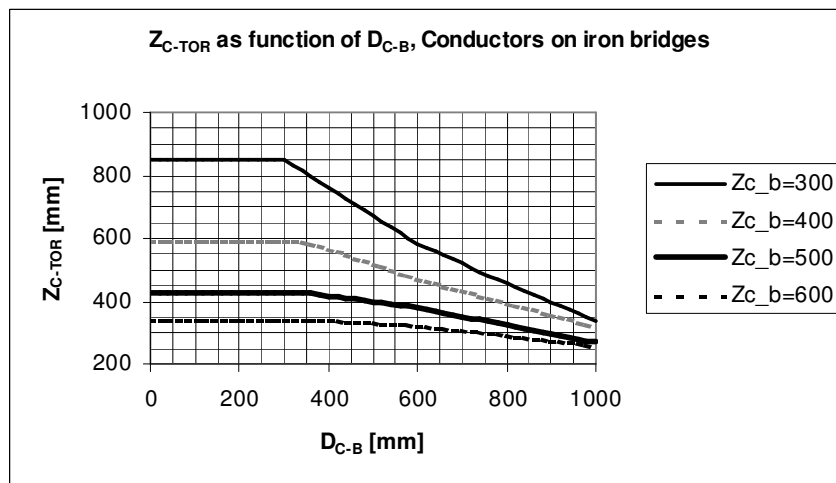

Figure 18: Distance, ' D_{C-B} ', between the Balise and a nearby conductor on iron bridges

4.6 Antenna Unit Installation Requirements

4.6.1 General

S The installation requirements of the antenna unit shall be fulfilled to ensure the Balise Detect ability of the combination of the On-board Transmission Equipment and the KER STM.

4.6.2 Allowed Displacement for the Antenna Units

The allowed displacements required to be specified for the antenna unit are defined in Annex F on page 76. The allowed displacements shall be specified by the antenna unit manufacturer.

4.6.3 Metal masses in the Track

Metal masses in the track may have a disturbing effect on the On-board Transmission Equipment. For example, metal masses may obstruct the ability of the On-board Transmission Equipment to check that it can detect a Balise.

The manufacturer of the On-board Transmission Equipment shall handle restrictions concerning metal masses in the track. The following metal masses are defined:

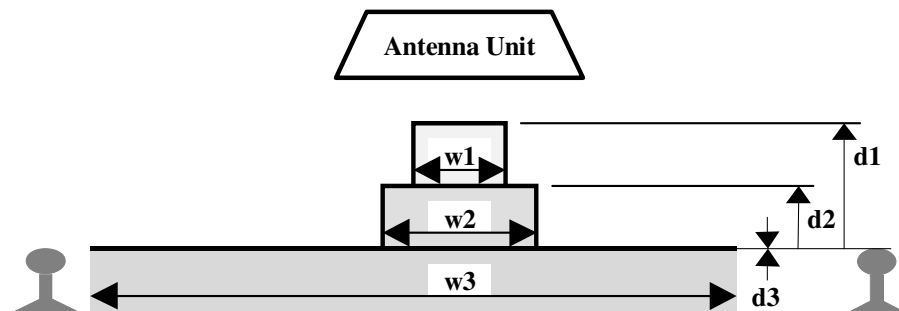

Width	Highest distance from top of rail	Examples of compatible metal structures
$w_1 \leq 120$ mm	$d_1 = 92$ mm	Applicable in France, Belgium, and Luxemburg.
$w_2 \leq 200$ mm	$d_2 = 50$ mm	The top of rail in points.
$w_3 > 200$ mm	$d_3 = 0$ mm	Plates for level crossing.

Figure 19: Metal masses in the track

The length of the object shall not exceed 10 m. The above defined shapes are considered part of this category of objects if they are positioned in the range between the specified maximum height of Figure 19 and 50 mm below the specified maximum height of Figure 19.

4.6.4 Antenna positioning along the x-axis

See Annex J on page 84, Annex K on page 86, Annex L on page 88, and Annex M on page 90.

4.7 Debris and Mismatch

The debris layers on top of the Balise are specified in Annex G on page 77.

S The debris requirements on top of the Balise must be fulfilled to assure the Balise Detect ability of the combination of the On-board Transmission Equipment and the KER STM.

The influence of debris affects the transmission in two ways:

1. The input-to-output characteristics of the Balise (e.g., the tuning of the Balise) are affected. This shall be considered in the Balise design.
2. The mutual coupling between Balise and antenna unit is affected. This shall be considered in the antenna unit design.

4.8 EMI and EMC

4.8.1 In-band Emission

4.8.1.1 Up-link Requirements

The Up-link signal complies with in-band emission levels as specified in the standard EN 50121-2 (see Ref. [4]), verified against EN 50121 or other national standard before the existence of EN50121.

The in-band frequency range for Up-link transmission is from 3.8 MHz to 5.2 MHz.

4.8.1.2 Tele-powering Requirements

The in-band emission from the On-board Transmission Equipment shall comply with EN 300 330 (see Ref. [2]). The applicable Tele-powering frequency mask is according to the following Figure 20.

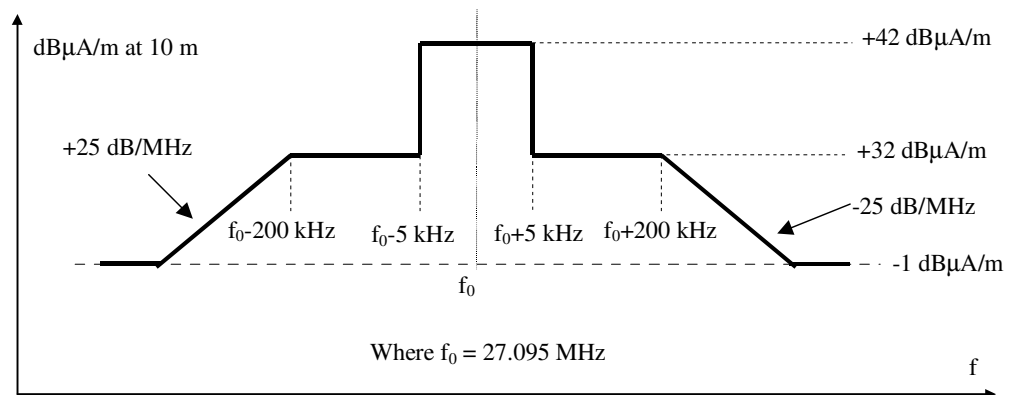

Figure 20: Tele-powering frequency mask

This shall apply to ERTMS based systems only.

4.8.2 Out-band Emission

4.8.2.1 Tele-powering Requirements

The out-band emission from the On-board Transmission Equipment shall comply with the applicable emission levels for the most restrictive profile specified in sub-clause 4.1 of EN 50121-2, Ref. [4], (Category C, 750 V DC Conductor Rail), reduced by 6 dB. This shall apply to ERTMS based systems only.

4.8.2.2 Up-link Requirements

Due to the intermittent operation of the Balise, i.e., it operates only when activated by the On-board antenna unit during a Balise passage, the Balise together with the On-board Transmission Equipment shall comply with the applicable emission levels for the most restrictive profile specified in sub-clause 4.1 of EN 50121-2, Ref. [4], (Category C, 750 V DC Conductor Rail), reduced by 6 dB. This shall apply to ERTMS based systems only.

4.8.3 Susceptibility

For the On-board Transmission Equipment, radiated immunity requirements shall comply with the applicable items of table 9 in clause 8 of EN 50121-3-2, Ref. [5]. This requirement does not apply for the frequency band 2.5 MHz to 6.0 MHz, nor for the frequency range ± 1.52 MHz centred on the Tele-powering carrier frequency. This shall apply to ERTMS based systems only.

5 Up-link (G1) Protocol

5.1 Start-up of the Transmission Link

When the field strength from the vehicle antenna is high enough, the Balise shall start to send the intended message. This must occur at a field strength equal to or lower than Φ_{d1} . The Balise start-up time shall be less than T_{BAL} μ s (defined in section 5.5 on page 54), beginning from when the field reaches Φ_{d1} .

When the Balise is not fully activated over Φ_{d1} , and not started yet, the Balise may make many repeated attempts to start.

5.2 Code Protection

Data and telegram structures shall be protected against possible noise effects in the air-gap and noise induced hazards in the receiving and transmitting equipment by suitable telegram coding algorithms.

5.3 Handshaking

No handshaking shall be required.

5.4 Disconnection

The telegram shall be sent uninterrupted as long as the Balise receives enough power from the On-board antenna unit.

5.5 Mode Transfer Syntax

The Balise shall have started to operate when the flux from the antenna unit has reached Φ_{d1} and after a time of T_{BAL} . Then it shall select operation mode in accordance with the kind of modulation of the interface 'G4' signal.

If the modulation is non-toggling or toggling AM, the Balise shall start to send the data using 50 kHz ASK modulation to the interface 'G1'.

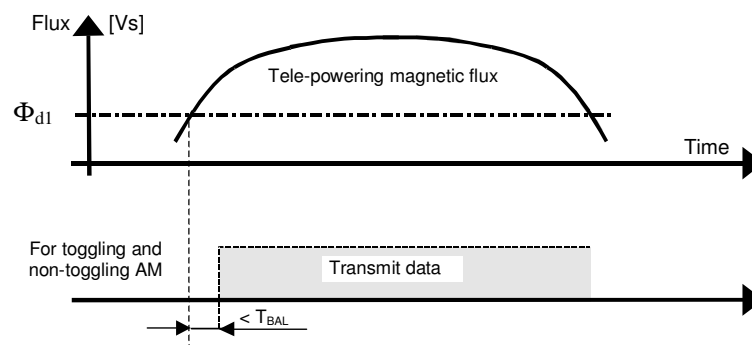

Figure 21: Timing diagram for Balise start-up

The start-up time, T_{BAL} , for the Balises is specified in Annex A through Annex E respectively.

6 RAMS Requirements

6.1 Transmission System Aspects

6.1.1 General

The transmission system aspects dealt with in this section (6.1) also considers system related issues for Interface 'K' as defined in the Interface 'K' specification (Ref. [6]).

6.1.2 Top-level Functionality

Table 7 below defines the top-level functionality of the entities of the Transmission System in terms of basic system oriented functions. Related failure modes are found in section 6.1.7 on page 58. The transmission system extension is from the encoder, or from the Balise, to the function where this data is created in the onboard system, e.g., the telegram receiver. The Interface 'K' is surrounded by this transmission system.

No.	Function Description	Related failure modes
F1	Balise Detection	FM1
F2	Transmit protected data from wayside devices to the intended train devices	FM2, FM5
F3	Provide data used for localisation of the train	FM3
F4	Allow understanding of the travelling direction of the train	FM4

Table 7: List of basic functions

6.1.3 Reliability

The entities of the Transmission System shall operate so as to ensure that reliability cross-talk from, and to, adjacent tracks does not adversely affect the overall reliability. Reliability cross-talk is defined as the disturbing effect on the correct transmission of data, such that correct transmission is unattainable.

6.1.4 Availability

The Balise Detect function implicitly measures the air-gap noise levels, and effectively constitutes an EMC level supervision. When the EMC level is above a level that ensures the required Balise transmission performance, then the combination of the On-board Transmission Equipment and the KER STM may perform Balise Detect. Thus, this implicitly includes EMC supervision, and triggers a vital fallback function (i.e., the Balise Detect functionality). The false alarm rate for the Balise Detect functionality is affecting the availability that must comply with the overall system level requirements.

6.1.5 Maintainability

Maintainability is supplier dependent, but shall be such that the stipulated availability targets are achieved.

6.1.6 Safety Related Functionality

6.1.6.1 Introduction

The functionality defined by Table 7 on page 55 is categorised safety related.

No single or multiple independent entity failure shall result in a rate exceeding the figures specified via section 6.3.2.1 on page 63. Secondary or dependent failures that occur as a result of an initial failure shall also be considered in combination with that initial failure.

6.1.6.2 Balise Detection

The ability to detect Balises is considered safety-critical, and constitutes a fall-back functionality in case the transmitted telegram can not be read by the combination of the On-board Transmission Equipment and the KER STM. The safety of this function is based on the passage of at least two Balises forming a Balise Group. A Balise Group is both defined by the logical content in the telegram, and by the physical distance between the Balises in the group and the distance between Balise Groups. Balise Groups are not mounted with the Balises interleaved. The minimum distance between the closest Balises in different Balise Groups is larger than the maximum distances between consecutive Balises within a Balise Group.

Information about wayside failures shall be passed on to the STM. This includes transmitting a Balise Detect without an accompanying valid telegram.

6.1.6.3 Transmission of Protected Data

Data and telegram structures shall be protected against possible noise effects in the air-gap and noise induced hazards in the receiving and transmitting equipment, by telegram coding algorithms.

The same coding algorithms shall protect data, and telegram structures, against noise and failures during transmission in the Balise controlling interface connecting the Encoder with the Balise (there is no bit error detection in the Balise).

Data transmitted from track to train is considered safety-critical. Protection of the data against noise effects and noise induced hazards in the receiving and transmitting equipment is considered sufficient for a system designed to provide acceptable availability when applying the coding requirements of the existing KER systems.

The entities of the Transmission System shall ensure protection against cross-talk based on signal levels when all constraints regarding the installation requirements are considered. The cross-talk protection can additionally be based on the reception of at least two Balises that are logically linked to each other. This protection, and the logical linking of these Balises, is performed on system level. Besides the logical protection there is also protection that the Balise Group is geometrically limited (maximum distance between Balises in the same group), and that the On-board function is not allowed to form a group of Balises that are reported with a distance too far from each other. Interleaved Balise Groups are not accepted by the On-board functionality (the minimum distance between the closest Balises in different Balise Groups is larger than the maximum distances between consecutive Balises within a Balise Group). The logical linking between Balises in a group is not always unique in that sense that only one Balise is the possible combination to create a Balise Group given a first Balise (or in the reverse order).

The entities of the Transmission System shall operate so that the probability for systematic safety cross-talk from, and to, adjacent tracks is sufficiently low.² Safety cross-talk is defined as the acceptance of unwanted data, interpreted as valid, by an unintended combination of On-board Transmission Equipment and KER STM.

² Additional protection is provided on system level through linking of Balise Groups (linking within Balise Groups with multiple Balises, and linking between Balise Groups).

6.1.6.4 Localisation

The antenna and BTM functionality shall be able to provide information suitable for detecting and evaluating the location reference of the Balise, and make this information available to the STM. This is based on the actual transfer of the bit sequence.

The localisation is mainly an STM functionality, related to the requirement on separation of succeeding Balises in the presence of potential side lobes. The safety of this function is based on the passage of a Balise Group. See further Ref. [6].

6.1.6.5 Travelling Direction

The entities of the Transmission System shall allow evaluation of the travel direction at each Balise Group. It is not allowed to mix the order of the Balises due to longitudinal cross-talk. The safety of this function is based on the passage a Balise Group, and/or the distance between Balise Groups and the distances between Balises within a Balise Group.

Information about Balise sequences shall be passed on to the STM function. It shall be correlated in such a way that the STM can identify that certain information is transmitted from a certain Balise.

The STM function will be able to determine the direction of validity of data from received telegrams, from the Balises within a Balise Group with two or several Balises.

6.1.7 Top-level Failure Modes

The top-level failure modes are defined in Table 8, together with their possible sources of the failure modes ³ and the related functionality of Table 7 in section 6.1.2 on page 55. Non-considered exceptional conditions outside the specification are not explicitly mentioned herein.

No.	Failure Mode Description	Related function	Possible origin of failure
FM1	A Balise Group is not detected	F1	Balise Air-gap On-board Transmission Equipment KER STM
FM2	Transmission of an erroneous telegram interpretable as correct	F2	Balise On-board Transmission Equipment KER STM LEU Air-gap Programming
FM3	Erroneous localisation of a Balise Group with reception of valid telegram ⁴	F3	Balise Air-gap On-board Transmission Equipment KER STM
FM4	The order of reported Balises, with reception of valid telegram, is erroneous	F4	Balise Air-gap On-board Transmission Equipment KER STM
FM5	Erroneous reporting of a Balise Group in a different track, with reception of valid telegram	F2	Balise Air-gap On-board Transmission Equipment KER STM

Table 8: List of top-level failure modes

The failure modes FM3, FM4, and FM5 are caused by technical failures within the respective entity.

Potential violation of installation rules is not considered in the quantification (indicated via section 6.3.2.1), but has to be considered by other means.

³ “Balise” includes e.g., the related installation rules for cables etc.

⁴ Longitudinal cross-talk is an example of a wayside source for this. Failure in the combination of the On-board Transmission Equipment and the KER STM regarding position and/or time reference of a Balise passage is an example of an on-board source.

6.2 Balise Aspects

6.2.1 General

The information in this section (6.2) is informative.

6.2.2 Balise Functionality

6.2.2.1 Overview

Table 9 below defines the functionality of the Balise, together with a linking to the top-level functionality of section 6.1.2 on page 55 and top-level failure modes of section 6.1.7 on page 58.⁵

Balise functionality:	Related top-level functions	Related top-level failure modes
Reception of Tele-powering signal	F1, F2	FM1 applies
Up-link signal generation	F1, F2	FM1 and FM2 apply
Data management	F2	FM2 applies
Limitation of the Up-link field	F2, F3, F4	FM3, FM4, and FM5 apply
Support to programming and management of operational/programming mode	F2	FM2 applies
Control of I/O characteristics	F1, F2, F3, F4	FM1, FM3, FM4, and FM5 apply
Cross-talk protection with other cables	F2, F3, F4	FM3, FM4, and FM5 apply

Table 9: Balise functionality and related top-level failure mode

6.2.2.2 Reception of Tele-powering Signal

It includes reception of energy from the air-gap, field conformity, AC/DC conversion and input power limitation. All operational, environmental and failure conditions that could inhibit the Balise from being energised at a level higher than the one corresponding to the minimum flux level of the applicable I/O characteristic is regarded as within the related failure mode.

6.2.2.3 Up-link Signal Generation

It includes modulation, control, transmission of the Up-link signal to the air-gap, and Up-link field conformity. All operational, environmental and failure conditions that could inhibit the Balise from generating the Up-link signal with electrical characteristics inside the allowed tolerances is regarded as within the related failure modes.

In case of incorrectness of the phase of the transmitted data bits relative to the Tele-powering transmission clock, this could prevent the On-board equipment from detecting Balises.

⁵ Only the defined functionality is mandatory, but not a specific structure or design solution.

6.2.2.4 Data Management

It includes Fixed or Default Telegram retention, data rate generation, memory management, and serialisation of data. All operational, environmental and failure conditions that could inhibit the Balise from sending the intended data, at the correct rate, to the Up-link signal generation function is regarded as within the related failure mode.

6.2.2.5 Limitation of the Up-link Field

It includes the upper limitation of the Up-link signal level in the allowed operational and environmental conditions (debris, temperature etc.). All operational, environmental and failure conditions that could inhibit the Balise from limiting an Up-link signal level to lower than the maximum level of the applicable I/O characteristic is regarded as within the related failure modes.

6.2.2.6 Support to Programming and Management of Operational/Programming Mode

It includes switching from normal operation mode to programming mode and vice-versa, under control of an external programming tool, reception, storage, and check of the programmed data. All operational, environmental and failure conditions that could generate the transmission of corrupted memory data is regarded as within the related failure mode.

6.2.2.7 Control of I/O Characteristics

It includes the combined control of incoming Tele-powering energy and of the Up-link signal level in the allowed operational and environmental conditions (debris, temperature etc.). All operational, environmental and failure conditions that could inhibit the Balise from transmitting an Up-link signal level higher than the minimum level, and lower than the maximum allowed level, of the applicable I/O characteristic is regarded as within the related failure modes.

6.2.2.8 Cross-talk Protection

Proper instructions for allowed layouts of cables crossing the tracks in the vicinity of a Balise, issued by the Balise manufacturer, shall minimise the risk of possible cross-talk occurrence according to the requirements of section 4.5.7 on page 46. The rules are defined so as to avoid cross-talk when the Balise and the On-board system are correctly operating. If components fail, there is a potential risk that the rules do not protect.

The possible cross-talk effects of unintentional cables crossing the tracks in the vicinity of a Balise, with undefined layouts, are not covered at Balise level.

6.3 On-board Equipment Aspects

6.3.1 Antenna and BTM Safety Functional Requirements

6.3.1.1 Overview

Table 10 below defines the functionality of the antenna and BTM functionality, together with a linking to the top-level functionality of section 6.1.2 on page 55 and top-level failure modes of section 6.1.7 on page 58.⁶

Antenna and BTM functionality:	Related top-level functions	Related top-level failure modes
Generation of correct Tele-powering signal	F1, F2	FM1 applies
Safe Transmission Supervision	F1	FM1 applies
Up-link signal filtering and demodulation	F1, F2	FM1 and FM2 apply
Physical Cross-talk protection	F1, F2, F3, F4	FM3, FM4, and FM5 apply
Provision of signals for Interface 'K' Supervision	F1	FM1 applies
Eurobalise Detection	F1, F2	FM1 applies

Table 10: On-board antenna and BTM functionality, and related top-level failure modes

Since the Interface 'G' and its use is tightly related to the Interface 'K' and the system oriented functionality, Table 10 should be read with considerations to the STM and ERTMS functionality as defined in Ref. [6] (Interface 'K' specification).

6.3.1.2 Generation of correct Tele-powering Signal

The On-board antenna and BTM function shall generate Tele-powering signal, fulfilling the requirements of this specification, used for energising the Balises.

6.3.1.3 Safe Transmission Supervision

The BTM function shall be responsible for the supervision of the safe integrity of the Balise Detect capability. Properties that are subject to supervision shall be:

- The level of field strength from the antenna unit.
- The receiver threshold.
- The modulation characteristics of the Tele-powering signal.

The BTM function may report sporadic unavailability in case the supervision has a sporadic loss of integrity. If the integrity is considered lost, the ERTMS/ETCS shall set the active STM to Failure State.

⁶ Only the defined functionality is mandatory, but not a specific structure or design solution.

6.3.1.4 Up-link signal Filtering and Demodulation

The Up-link signal received by the antenna should be subject to band pass filtering in order to suppress environmental noise. After filtering, the signal shall be demodulated in order to determine if a certain bit is 'one' (no energy) or a 'zero' (energy).

6.3.1.5 Physical Cross-talk Protection

The physical cross-talk protection shall be based on:

- The fulfilment of the Balise field conformity requirements.
- The fulfilment of the Balise input-to output characteristic.
- The installation requirements for Balises in proximity of extraneous cables or metallic objects.
- The electrical and company specific installation requirements for Balise controlling interface cables.
- The minimum value of the field strength threshold of the BTM function receiver, V_{th} , which is sufficiently high to correctly handle possible up-link signal received from an activated Balise in the cross-talk protected zone.
- The Tele-powering field generated by the On-board Antenna Unit in the worst case Tele-powering field condition, reaching a Balise in a cross-talk protected zone, which is low enough not to activate it to a level that the Up-link signal is correctly received by the first Antenna Unit.

6.3.1.6 Provision of Signals for Interface 'K' Supervision

The BTM function shall provide signals for supervision of Interface 'K' as defined in Ref. [6] (Interface 'K' specification).

6.3.1.7 Eurobalise Detection

In order to make it possible for the STM to extract user data according to the applicable coding strategy, it is necessary to provide knowledge if Eurobalise data is transmitted via Interface 'K'. In such a case, the information (including the related Balise Detect event) shall be ignored by the STM. This shall be performed using the Data Corrupted data as defined in Ref. [6] (Interface 'K' specification).

Please observe that it is a safety related issue to not erroneously report Eurobalise detection also for KER Balises.

6.3.2 Safety Integrity Requirements

6.3.2.1 Quantification

Table 11 defines the requirements that shall be fulfilled for the antenna and BTM functionality failure modes when assuming that the specified maintenance is fulfilled.

The functional failures related to cross-talk in the above sections (FM3 through FM5) are here replaced with the technical failure leading to cross-talk (denominated O1 and O2), in order to be able to define allowed likelihood of unavailability.

The quantitative targets of Table 11 below are system specific and are found in Annex J, Annex K, Annex L, and Annex M respectively. Where applicable, also additional system specific safety requirements are found in these annexes. The targets concern failures that can not be detected by the supervision functions of the STM functionality.

No.	Failure Mode Description	Balise group	
		WSF rate [f/h]	Unavailability
FM1 _G	A Balise Group is not detectable when indicating safe operation	System specific	-
FM2 _G	Storage of more than 31 bits of data, or data is not delivered in the same order as in the air-gap	System specific	-
O1	On-board equipment too sensitive to Up-link	-	System specific
O2	On-board equipment has too strong Tele-powering	-	System specific

Table 11: Targets for antenna and BTM functionality

O1 means that the antenna and BTM functionality is more sensitive to the Up-link field than expected. It is assumed that it can not be more than 30 dB sensitive than a fault free equipment.

O2 means that the antenna and BTM functionality is transmitting more Tele-powering field than specified. It is assumed that it can not transmit more than 10 dB higher field strength than specified (i.e., not more than $\phi_{d4} + 10$ dB).

The figures might originate from a hardware failure, and is thus dependent on MTTR (including the detection time) and the actual failure frequency. The combination of these aspects is the sums quantified in Annex J, Annex K, Annex L, and Annex M respectively.⁷

⁷ In which relation those failure modes are related to safety is determined by hazard analyses on higher system level.

6.3.2.2 Independence of Failure Mode Causes

For some of the failure modes, dependencies also have to be considered when calculating the figures of Table 11 on page 63.

Crosswise unavailability of each type of failure mode is independent between the On-board Transmission Equipment and the Balise.

Effects of faults shall be analysed in the presence of noise from the air-gap. If the actual worst case noise situation is known, then the faults shall be analysed against this known noise effect, otherwise if the effect is unknown then any ratio of random decoded bit error rate shall be analysed.

6.3.2.3 Conditions/Assumptions

The apportionment of the figures of Table 11 on page 63 is based on the following presumptions:

- The Mean Time to Restore (MTTR) is irrelevant for the purpose of the quantification included in section 6.3.2.1 on page 63 (a faulty On-board Transmission Equipment results in the vehicle being taken out of operation).
- The mean time for detection of On-board Transmission Equipment failures is company specific, and might differ between the various failure modes of section 6.3.2.1 on page 63. The Mission Profile defined in higher system level documentation shall be considered in the company specific choices.
- The dependencies with air-gap related aspects shall be considered.
- Only random aspects are included.
- All figures are based on mean detection times. The analyses should be supported by sensitivity analyses wherever deemed necessary.
- For the purpose of failure mode FM2_G, it is assumed that a selection of continuous parts is sent in the same order as the data is received. Data must not be memorised in such a way that it can be sent more than once.

The following aspects are not within the scope of the quantification of Table 11 on page 63:

- Vandalism
- Exceptional occurrences (e.g., exceptional environmental conditions outside specification)
- Erroneous installation
- Erroneous maintenance
- Occupational Health
- Mechanical damage due to maintenance (causing conditions outside specification)

The quantification should, as far as possible, be based on data acquired by experience. If such data is not available, data from MIL-HDBK 217 or other similar recognised database should be used. Data may be tailored considering manufacturer experience (if available), but explicit justifications are required.

7 References

Ref. Number	Document number	Description
1	UNISIG SUBSET-036	FFFIS for Eurobalise
2	EN 300 330 Part 1 and Part 2, June 2001	Radio Equipment and Systems (RES); Short Range Devices (SRDs) Technical characteristics and test methods for radio equipment in the frequency range 9 kHz to 25 MHz and inductive loop systems in the frequency range 9 kHz to 30 MHz
3	EN 50121-4 September 2000	Railway applications – Electromagnetic compatibility Part 4: Emission and immunity of the signalling and telecommunications apparatus
4	EN 50121-2 September 2000	Railway applications – Electromagnetic compatibility Part 2: Emission of the railway system to the outside world
5	EN 50121-3-2 September 2000	Railway applications - Electromagnetic compatibility Part 3: Rolling stock, Section 2: Apparatus
6	UNISIG SUBSET-101	Interface 'K' Specification
7	UNISIG SUBSET-040	Engineering Rules

Annex A, Balise Type A specific parameters

A1 General

This annex defines the specific Interface ‘G’ parameters of the Balise Type A.

A2 Timing Requirements

- S The delay t_{pudelay} , as defined in section 3.2.3 on page 30, for the Balise Type A shall be $t_{\text{pudelay_A}}$, with a tolerance $t_{\text{putoL_A}}$.
- $t_{\text{pudelay_A}} = 0.8 \mu\text{s}$
 - $t_{\text{putoL_A}} = +0.6/-0.2 \mu\text{s}$
 - $t_{\text{pudelay_A}}$ is defined from the 50 % level of the falling edge of the Tele-powering modulation envelope.

A3 Input-to-output Characteristics

- S The input-to-output characteristics are defined in section 4.3.3.1 on page 36, and the performance of the Balise input-to-output characteristics for the different conditions is specified below.

The influence from debris (according to Annex G on page 77), and from approved mounting details (see section 4.5.4 on page 45), are included in the values specified in Table 12 (refer to Figure 10 on page 36).

$\Phi_{d4} = 300 \text{ nVs}$ and $\Phi_{d5} = 300 \text{ nVs}$ for all debris conditions.

Nominal	$I_{u0} = 8 \text{ mA}$	$I_{u1} = 30 \text{ mA}$	$I_{u2} = 105 \text{ mA}$	$I_{u3} = 136 \text{ mA}$
	$\Phi_{d0} = 2.6 \text{ nVs}$	$\Phi_{d1} = 8.5 \text{ nVs}$	$\Phi_{d2} = 16 \text{ nVs}$	$\Phi_{d3} = 9 \text{ nVs}$
Clear water, 100 mm	$I_{u0} = 8 \text{ mA}$	$I_{u1} = 25 \text{ mA}$	$I_{u2} = 105 \text{ mA}$	$I_{u3} = 136 \text{ mA}$
	$\Phi_{d0} = 4 \text{ nVs}$	$\Phi_{d1} = 8.5 \text{ nVs}$	$\Phi_{d2} = 20 \text{ nVs}$	$\Phi_{d3} = 12 \text{ nVs}$
Salt water, 100 mm	$I_{u0} = 8 \text{ mA}$	$I_{u1} = 25 \text{ mA}$	$I_{u2} = 90 \text{ mA}$	$I_{u3} = 136 \text{ mA}$
	$\Phi_{d0} = 3.2 \text{ nVs}$	$\Phi_{d1} = 9.5 \text{ nVs}$	$\Phi_{d2} = 20 \text{ nVs}$	$\Phi_{d3} = 12 \text{ nVs}$
Dry iron ore, 10 mm	$I_{u0} = 8 \text{ mA}$	$I_{u1} = 25 \text{ mA}$	$I_{u2} = 105 \text{ mA}$	$I_{u3} = 136 \text{ mA}$
	$\Phi_{d0} = 4 \text{ nVs}$	$\Phi_{d1} = 7 \text{ nVs}$	$\Phi_{d2} = 16 \text{ nVs}$	$\Phi_{d3} = 10 \text{ nVs}$
Wet iron ore, 10 mm	$I_{u0} = 8 \text{ mA}$	$I_{u1} = 25 \text{ mA}$	$I_{u2} = 80 \text{ mA}$	$I_{u3} = 136 \text{ mA}$
	$\Phi_{d0} = 4 \text{ nVs}$	$\Phi_{d1} = 10 \text{ nVs}$	$\Phi_{d2} = 22 \text{ nVs}$	$\Phi_{d3} = 12 \text{ nVs}$

Table 12: Input-to-output characteristics for the Balise Type A

A4 Balise Impedance

The Balise impedance is defined in section 4.3.3.3 on page 40.

The complex impedance $Z_{\text{reflected_A}}$ of the Balise Type A shall be $|Z_{\text{reflected_A}}| > 40 \Omega$ and $\text{Im } Z_{\text{reflected_A}} > 0 \Omega$ when the Balise receives a flux up to $\Phi_{d4} +0/-3 \text{ dB}$.

A5 Start-up Time of the Balise

The parameters to determine the contact distance for telegram transmission are defined in section 4.3.3.2 on page 37.

The start up time, T_{BAL} , for the Balise Type A is maximum 20 μs . T_{BAL} is defined in section 5.5 on page 54.

Annex B, Balise Type B specific parameters

B1 General

This annex defines the specific Interface ‘G’ parameters of the Balise Type B.

B2 Timing Requirements

- S The delay $t_{pudelay}$, as defined in section 3.2.3 on page 30, for the Balise Type B shall be $t_{pudelay_B}$, with a tolerance t_{putol_B} .
- $t_{pudelay_B} = 1.04 \mu\text{s}$
 - $t_{putol_B} = +0.27 / -0.15 \mu\text{s}$
 - $t_{pudelay_B}$ is defined from the 90 % level of the falling edge of the Tele-powering modulation envelope.

B3 Input-to-output Characteristics

- S The input-to-output characteristics are defined in section 4.3.3.1 on page 36, and the performance of the Balise input-to-output characteristics for the different conditions is specified below.

The influence from debris (according to Annex G on page 77), and from approved mounting details (see section 4.5.4 on page 45), are included in the values specified in Table 13 (refer to Figure 10 on page 36).

$\Phi_{d4} = 300 \text{ nVs}$ and $\Phi_{d5} = 300 \text{ nVs}$ for all debris conditions.

Nominal	$I_{u0} = 11 \text{ mA}$	$I_{u1} = 50 \text{ mA}$	$I_{u2} = 110 \text{ mA}$	$I_{u3} = 145 \text{ mA}$
	$\Phi_{d0} = 4 \text{ nVs}$	$\Phi_{d1} = 7 \text{ nVs}$	$\Phi_{d2} = 17 \text{ nVs}$	$\Phi_{d3} = 12 \text{ nVs}$
Clear water, 100 mm	$I_{u0} = 11 \text{ mA}$	$I_{u1} = 50 \text{ mA}$	$I_{u2} = 110 \text{ mA}$	$I_{u3} = 145 \text{ mA}$
	$\Phi_{d0} = 4 \text{ nVs}$	$\Phi_{d1} = 9 \text{ nVs}$	$\Phi_{d2} = 18 \text{ nVs}$	$\Phi_{d3} = 12 \text{ nVs}$
Salt water, 100 mm	$I_{u0} = 11 \text{ mA}$	$I_{u1} = 50 \text{ mA}$	$I_{u2} = 90 \text{ mA}$	$I_{u3} = 145 \text{ mA}$
	$\Phi_{d0} = 4 \text{ nVs}$	$\Phi_{d1} = 10 \text{ nVs}$	$\Phi_{d2} = 19 \text{ nVs}$	$\Phi_{d3} = 12 \text{ nVs}$
Dry iron ore, 10 mm	$I_{u0} = 11 \text{ mA}$	$I_{u1} = 55 \text{ mA}$	$I_{u2} = 120 \text{ mA}$	$I_{u3} = 145 \text{ mA}$
	$\Phi_{d0} = 4 \text{ nVs}$	$\Phi_{d1} = 8 \text{ nVs}$	$\Phi_{d2} = 16 \text{ nVs}$	$\Phi_{d3} = 12 \text{ nVs}$
Wet iron ore, 10 mm	$I_{u0} = 8 \text{ mA}$	$I_{u1} = 50 \text{ mA}$	$I_{u2} = 86 \text{ mA}$	$I_{u3} = 145 \text{ mA}$
	$\Phi_{d0} = 4 \text{ nVs}$	$\Phi_{d1} = 10 \text{ nVs}$	$\Phi_{d2} = 19 \text{ nVs}$	$\Phi_{d3} = 12 \text{ nVs}$

Table 13: Input-to-output characteristics for the Balise Type B

B4 Balise Impedance

The Balise impedance is defined in section 4.3.3.3 on page 40.

The complex impedance $Z_{\text{reflected_B}}$ of the Balise Type B shall be $|Z_{\text{reflected_B}}| > 60 \Omega$ when the Balise receives a flux up to $\Phi_{d4} +0/-3$ dB.

B5 Start-up Time of the Balise

The parameters to determine the contact distance for telegram transmission are defined in section 4.3.3.2 on page 37.

T_{BAL} is defined in section 5.5 on page 54.

The start up time, T_{BAL} , for the Balise Type B is:

- Fixed Balise: 400 μs .
20 μs for sending a continuous stream of '0' for Balise detect.
- Controlled Balise: 240 μs .
20 μs for sending a continuous stream of '0' for Balise detect.

Annex C, Balise Type C specific parameters

C1 General

This annex defines the specific Interface ‘G’ parameters of the Balise Type C.

C2 Timing Requirements

- S The delay t_{pudelay} , as defined in section 3.2.3 on page 30, for the Balise Type C shall be $t_{\text{pudelay_C}}$, with a tolerance $t_{\text{putol_C}}$.
- $t_{\text{pudelay_C}} = 1.3 \mu\text{s}$
 - $t_{\text{putol_C}} = +0.35 / -0.45 \mu\text{s}$
 - $t_{\text{pudelay_C}}$ is defined from the 90 % level of the falling edge of the Tele-powering modulation envelope.

C3 Input-to-output Characteristics

- S The input-to-output characteristics are defined in section 4.3.3.1 on page 36, and the performance of the Balise input-to-output characteristics for the different conditions is specified below.

The influence from debris (according to Annex G on page 77), and from approved mounting details (see section 4.5.4 on page 45), are included in the values specified in Table 14 (refer to Figure 10 on page 36).

$\Phi_{d4} = 130 \text{ nVs}$ and $\Phi_{d5} = 130 \text{ nVs}$ for all debris conditions, measured with a Reduced Size Reference Loop.

Nominal	$I_{u0} = 30 \text{ mA}$	$I_{u1} = 112 \text{ mA}$	$I_{u2} = 215 \text{ mA}$	$I_{u3} = 360 \text{ mA}$
	$\Phi_{d0} = 2.6 \text{ nVs}$	$\Phi_{d1} = 5.5 \text{ nVs}$	$\Phi_{d2} = 11 \text{ nVs}$	$\Phi_{d3} = 8 \text{ nVs}$
Clear water, 100 mm	$I_{u0} = 30 \text{ mA}$	$I_{u1} = 25 \text{ mA}$	$I_{u2} = 220 \text{ mA}$	$I_{u3} = 340 \text{ mA}$
	$\Phi_{d0} = 2.6 \text{ nVs}$	$\Phi_{d1} = 5 \text{ nVs}$	$\Phi_{d2} = 13 \text{ nVs}$	$\Phi_{d3} = 8 \text{ nVs}$
Salt water, 100 mm	$I_{u0} = 30 \text{ mA}$	$I_{u1} = 25 \text{ mA}$	$I_{u2} = 200 \text{ mA}$	$I_{u3} = 310 \text{ mA}$
	$\Phi_{d0} = 2.6 \text{ nVs}$	$\Phi_{d1} = 5 \text{ nVs}$	$\Phi_{d2} = 13 \text{ nVs}$	$\Phi_{d3} = 8 \text{ nVs}$

Table 14: Input-to-output characteristics for the Balise Type C

Figures of Table 14 above refer to measurements with a Reduced Size Reference Loop.

C4 Balise Impedance

The Balise impedance is defined in section 4.3.3.3 on page 40.

The complex impedance $Z_{\text{reflected_C}}$ of the Balise Type C shall be $|Z_{\text{reflected_C}}| > 40 \Omega$ when the Balise receives a flux up to $\Phi_{d4} +0/-3$ dB.

C5 Start-up Time of the Balise

The parameters to determine the contact distance for telegram transmission are defined in section 4.3.3.2 on page 37.

T_{BAL} is defined in section 5.5 on page 54.

The start up time, T_{BAL} , for the Balise Type C is:

- Fixed Balise: 80 μs .
20 μs for sending a continuous stream of '0' for Balise detect.
- Controlled Balise: 460 μs .
20 μs for sending a continuous stream of '0' for Balise detect.

Annex D, Balise Type D specific parameters

D1 General

This annex defines the specific Interface ‘G’ parameters of the Balise Type D.

D2 Timing Requirements

S The delay t_{pudelay} , as defined in section 3.2.3 on page 30, for the Balise Type E shall be $t_{\text{pudelay_D}}$, with a tolerance $t_{\text{putol_D}}$.

- $t_{\text{pudelay_D}} = 0.8 \mu\text{s}$
- $t_{\text{putol_D}} = +0.6/-0.2 \mu\text{s}$
- $t_{\text{pudelay_D}}$ is defined from the 50 % level of the falling edge of the Tele-powering modulation envelope.

D3 Input-to-output Characteristics

S The input-to-output characteristics are defined in section 4.3.3.1 on page 36, and the performance of the Balise input-to-output characteristics for the different conditions is specified below.

The influence from debris (according to Annex G on page 77), and from approved mounting details (see section 4.5.4 on page 45), are included in the values specified in Table 15 (refer to Figure 10 on page 36).

$\Phi_{d4} = 200 \text{ nVs}$ and $\Phi_{d5} = 300 \text{ nVs}$ for all debris conditions.

Nominal	$I_{u0} = 8 \text{ mA}$	$I_{u1} = 30 \text{ mA}$	$I_{u2} = 105 \text{ mA}$	$I_{u3} = 150 \text{ mA}$
	$\Phi_{d0} = 2.6 \text{ nVs}$	$\Phi_{d1} = 8.5 \text{ nVs}$	$\Phi_{d2} = 16 \text{ nVs}$	$\Phi_{d3} = 9 \text{ nVs}$
Snow, 50 mm	$I_{u0} = 8 \text{ mA}$	$I_{u1} = 30 \text{ mA}$	$I_{u2} = 105 \text{ mA}$	$I_{u3} = 150 \text{ mA}$
	$\Phi_{d0} = 2.6 \text{ nVs}$	$\Phi_{d1} = 8.5 \text{ nVs}$	$\Phi_{d2} = 16 \text{ nVs}$	$\Phi_{d3} = 9 \text{ nVs}$
Clear Water, 100 mm	$I_{u0} = 8 \text{ mA}$	$I_{u1} = 25 \text{ mA}$	$I_{u2} = 105 \text{ mA}$	$I_{u3} = 150 \text{ mA}$
	$\Phi_{d0} = 4 \text{ nVs}$	$\Phi_{d1} = 8.5 \text{ nVs}$	$\Phi_{d2} = 20 \text{ nVs}$	$\Phi_{d3} = 12 \text{ nVs}$
Salt water, 100 mm	$I_{u0} = 8 \text{ mA}$	$I_{u1} = 25 \text{ mA}$	$I_{u2} = 90 \text{ mA}$	$I_{u3} = 150 \text{ mA}$
	$\Phi_{d0} = 3.2 \text{ nVs}$	$\Phi_{d1} = 9.5 \text{ nVs}$	$\Phi_{d2} = 20 \text{ nVs}$	$\Phi_{d3} = 12 \text{ nVs}$

Table 15: Input-to-output characteristics for the Balise Type D

D4 Balise Impedance

The Balise impedance is defined in section 4.3.3.3 on page 40.

The complex impedance $Z_{\text{reflected_D}}$ of the Balise Type D shall be $|Z_{\text{reflected_D}}| > 40 \Omega$ and $\text{Im } Z_{\text{reflected_D}} > 0 \Omega$ when the Balise receives a flux up to $\Phi_{d4} +0/-3 \text{ dB}$.

D5 Start-up Time of the Balise

The parameters to determine the contact distance for telegram transmission are defined in section 4.3.3.2 on page 37.

The start up time, T_{BAL} , for the Balise Type D is maximum 60 μs . T_{BAL} is defined in section 5.5 on page 54.

Annex E, Balise Type E specific parameters

E1 General

This annex defines the specific Interface ‘G’ parameters of the Balise Type E.

E2 Timing Requirements

S The delay t_{pdelay} , as defined in section 3.2.3 on page 30, for the Balise Type E shall be t_{pdelay_E} , with a tolerance t_{putol_E} .

- $t_{\text{pdelay}_E} = 1.4 \mu\text{s}$
- $t_{\text{putol}_E} = +0.5/-0.2 \mu\text{s}$
- t_{pdelay_E} is defined from the 90 % level of the falling edge of the Tele-powering modulation envelope.

E3 Input-to-output Characteristics

S The input-to-output characteristics are defined in section 4.3.3.1 on page 36, and the performance of the Balise input-to-output characteristics for the different conditions is specified below.

The influence from debris (according to Annex G on page 77), and from approved mounting details (see section 4.5.4 on page 45), are included in the values specified in Table 16 (refer to Figure 10 on page 36).

$\Phi_{d4} = 200 \text{ nVs}$ and $\Phi_{d5} = 300 \text{ nVs}$ for all debris conditions.

Nominal	$I_{u0} = 11 \text{ mA}$	$I_{u1} = 60 \text{ mA}$	$I_{u2} = 100 \text{ mA}$	$I_{u3} = 210 \text{ mA}$
	$\Phi_{d0} = 4 \text{ nVs}$	$\Phi_{d1} = 11.5 \text{ nVs}$	$\Phi_{d2} = 17 \text{ nVs}$	$\Phi_{d3} = 13 \text{ nVs}$
Snow, 50 mm	$I_{u0} = 11 \text{ mA}$	$I_{u1} = 60 \text{ mA}$	$I_{u2} = 100 \text{ mA}$	$I_{u3} = 210 \text{ mA}$
	$\Phi_{d0} = 4 \text{ nVs}$	$\Phi_{d1} = 11.5 \text{ nVs}$	$\Phi_{d2} = 17 \text{ nVs}$	$\Phi_{d3} = 13 \text{ nVs}$
Clear Water, 100 mm	$I_{u0} = 11 \text{ mA}$	$I_{u1} = 30 \text{ mA}$	$I_{u2} = 100 \text{ mA}$	$I_{u3} = 210 \text{ mA}$
	$\Phi_{d0} = 4 \text{ nVs}$	$\Phi_{d1} = 16.3 \text{ nVs}$	$\Phi_{d2} = 25 \text{ nVs}$	$\Phi_{d3} = 18 \text{ nVs}$
Salt water, 100 mm	$I_{u0} = 11 \text{ mA}$	$I_{u1} = 30 \text{ mA}$	$I_{u2} = 100 \text{ mA}$	$I_{u3} = 210 \text{ mA}$
	$\Phi_{d0} = 4 \text{ nVs}$	$\Phi_{d1} = 18.3 \text{ nVs}$	$\Phi_{d2} = 28 \text{ nVs}$	$\Phi_{d3} = 20 \text{ nVs}$

Table 16: Input-to-output characteristics for the Balise Type E

E4 Balise Impedance

The Balise impedance is defined in section 4.3.3.3 on page 40.

The complex impedance $Z_{\text{reflected_E}}$ of the Balise Type E shall be $|Z_{\text{reflected_E}}| > 40 \Omega$ and $\text{Im } Z_{\text{reflected_E}} > 0 \Omega$ when the Balise receives a flux up to $\Phi_{d4} +0/-3 \text{ dB}$.

E5 Start-up Time of the Balise

The parameters to determine the contact distance for telegram transmission are defined in section 4.3.3.2 on page 37.

T_{BAL} is defined in section 5.5 on page 54.

The start up time, T_{BAL} , for the Balise Type E is maximum 1.7 ms.

Annex F, Antenna Unit Displacements

F1 Antenna Unit Displacements

The allowed static, dynamic and total displacements of the antenna units relative to the track shall be specified by the antenna unit manufacturer. The reference positioning system defined in section 2.4 on page 22 shall be utilised. The following parameters shall be defined:

- The minimum vertical distance from the reference marks of the antenna unit to the top of rails.
- The maximum vertical distance from the reference marks of the antenna unit to the top of rails.
- The total maximum lateral deviation between the Z-reference mark of the antenna unit and the centre axis⁸ of the track.
- Maximum tilting of the antenna unit.
- Maximum yawing of the antenna unit.
- Maximum pitching of the antenna unit.

⁸ The centre axis of the track is located half the distance between the web of the rails. The value of the lateral deviation shall include the influence from lateral rail wear.

Annex G, Debris and Mismatch

G1 Debris and Mismatch

S Table 17 defines the maximum allowed debris layers on top of the Balise. In the heading of Table 17 below, “Layer” refers to the maximum layer on top of the Balise.

The parameters of the specific Balises referred to herein are in accordance with Annex A through Annex E.

Denomina- tion	Mate- rial	Description	Layer [mm]	Balise Type A	Balise Type B	Balise Type C	Balise Type D	Balise Type E
Clear Water	Water	Clear	100	X	X	X	X	X
Salt water	Water	0.10 % NaCl ⁹	100	X	X	X	X	X
Dry iron ore	Iron ore	Magnetite, dry	10	X	X			
Wet iron ore	Iron ore	Magnetite, wet	10	X	X			
Snow	Snow		50				X	X
Nominal	None	Free air	-	X	X	X	X	X

Table 17: Debris layers on top of the Balise

Figure 22 and Figure 23 specifies the way in which the debris shall be applied on the Balise under test.

⁹ The figure states the weight percent.

When debris is a fluid, e.g. water:

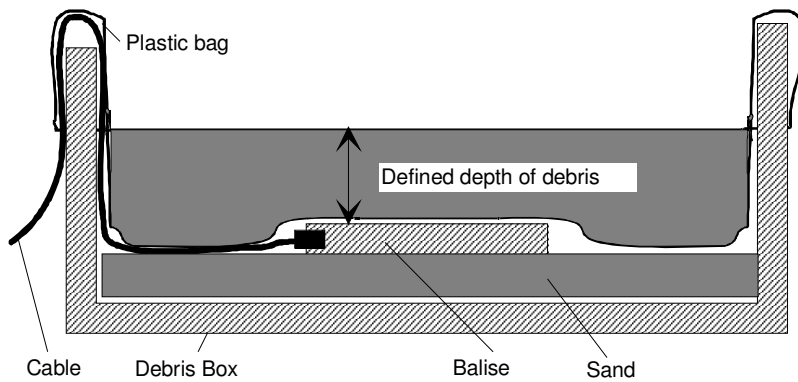

Figure 22: Debris box, fluid debris

When debris is in solid form, e.g. iron ore:

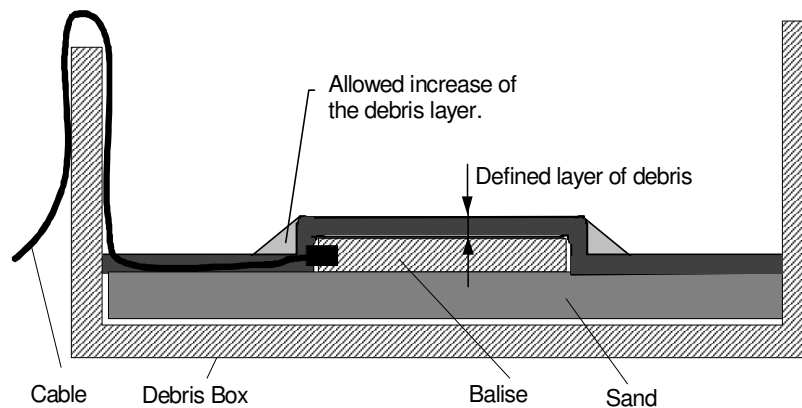

Figure 23: Debris box, solid debris

It is allowed to increase the layer of solid debris at the right angle edges of the debris as shown in the lower part of Figure 23.

The inner size of the non-conductive debris box shall be 122 × 95 cm (X-direction × Y-direction).

The metal free volume around the Balise during the debris tests shall be according to Figure 24.

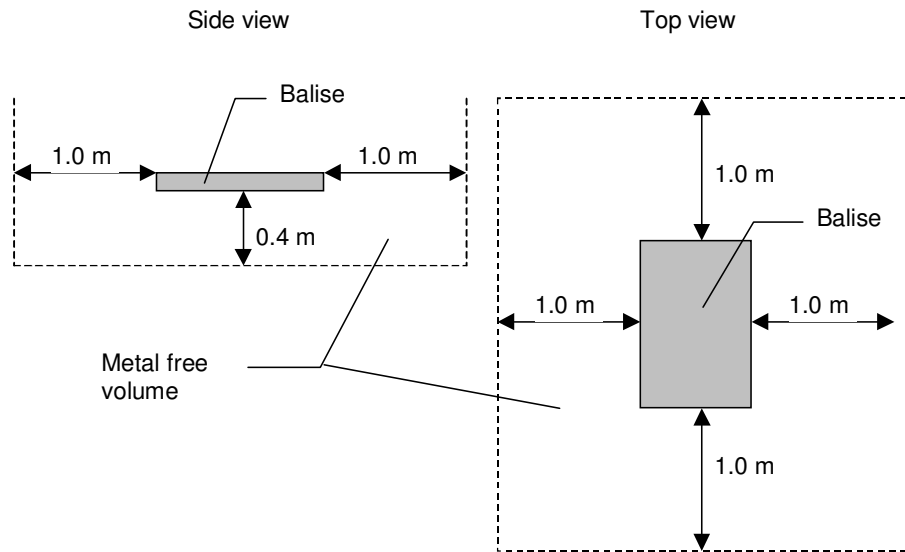

Figure 24: Metal free volume around the Balise during debris tests

Annex H, Balise Orientation in Relation to the Rails

H1 General

This annex defines the static and dynamic displacements of the Balise relative to the track. The reference positioning system defined in section 2.4 on page 22 is relevant.

Both general and country specific installation applications are defined for the Balises. The country specific installation applications are valid for the specific market only.

The parameters of the specific Balises referred to herein are in accordance with Annex A through Annex E.

Table 2 on page 12 shows the different markets where the Balises are used and the installation applies. The general installation applications are defined in section H2 and the country specific installation applications are defined in section H3.

H2 General Balise Installation Applications

The general installation application for the Balises is specified in Table 18.

Displacement	Balise Type A	Balise Type B	Balise Type C	Balise Type D	Balise Type E
The minimum distance from top of rail to the X _{balise} and Y _{balise} axes ¹⁰	142 mm	150 mm	150 mm	- ¹¹	- ¹¹
The maximum distance from top of rail to the X _{balise} and Y _{balise} axes ¹²	162 mm	170 mm	170 mm	- ¹¹	- ¹¹
The maximum lateral deviation between the Z reference mark of the Balise and the centre axis of the track ¹³	±20 mm	±20 mm	±20 mm	- ¹¹	- ¹¹
The maximum tilting of the Balise related to the X-axis	±2 °	±2 °	±2 °	±5 °	±5 °
The maximum pitching of the Balise, related to the Y-axis	±5 °	±5 °	±5 °	±5 °	±5 °
The maximum yawing of the Balise, related to the Z-axis	±2 °	±2 °	±2 °	±5 °	±5 °

Table 18: General installation application

For the purpose of the Balise Type C, only transversal mounting applies (i.e., the longer side of the Balise is in parallel with the sleeper).

¹⁰ The reduction for the height of the rail according to rail wear must be considered.

¹¹ Only country specific installation requirements apply. See section H3.4.1 on page 82.

¹² In situations where the mounting surface is too low, in order not to exceed the maximum height value, a distance block of a non-conductive material shall be put between the Balise and the mounting surface.

¹³ The centre axis of the track is located half the distance between the web of the rails. The value of the lateral tolerance does not include the influence from lateral rail wear. (This shall instead be considered in the dynamic displacement of the antenna unit, as specified in section 4.6.2 on page 49).

H3 Country Specific Installation Applications

H3.1 General

The country specific installation applications are valid for the specified market/system only.

H3.2 Ebicab 700 Transmission System, Sweden

H3.2.1 Change of Vertical Position of the Balise

This does not apply for Balises installed in between guard rails or closer than 20 m from points.

Displacement	Balise Type A	Balise Type B
The minimum distance from top of rail to the X_{balise} and Y_{balise} axes	142 mm	150 mm
The maximum distance from top of rail to the X_{balise} and Y_{balise} axes	200 mm	208 mm

Table 19: Vertical position of the Balise

H3.2.2 Cutting of Guard Rails close to a Balise

The Balise can be installed in between the guard rails if the guard rails are cut as shown in Figure 25.

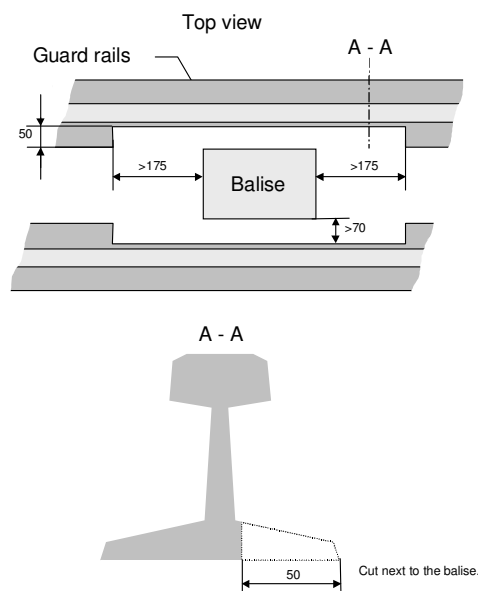

Figure 25: Cutting of guard rails close to the Balise

H3.3 Ebicab 700 Transmission System, Norway

H3.3.1 Change of Vertical Position of the Balise

This does not apply for Balises installed in between guard rails or closer than 20 m from points.

Displacement	Balise Type A	Balise Type B
The minimum distance from top of rail to the X_{balise} and Y_{balise} axes	142 mm	150 mm
The maximum distance from top of rail to the X_{balise} and Y_{balise} axes	200 mm	208 mm

Table 20: Vertical position of the Balise

H3.3.2 Cutting of Guard Rails close to a Balise

The Balise can be installed in between the guard rails if the guard rails are cut as shown in Figure 25.

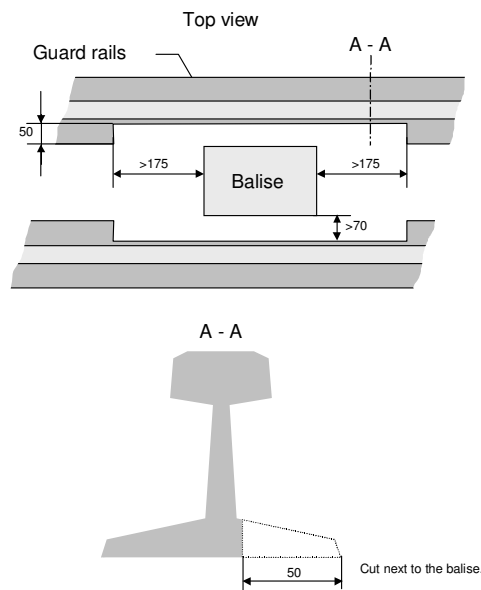

Figure 26: Cutting of guard rails close to the Balise

H3.4 KVB Transmission System, France

H3.4.1 Change of Vertical Position of the Balise

Displacement	Balise Type D	Balise Type E
The minimum distance from top of rail to the X_{balise} and Y_{balise} axes	98 mm	98 mm
The maximum distance from top of rail to the X_{balise} and Y_{balise} axes	178 mm	178 mm

Table 21: Vertical position of the Balise

H3.4.2 Lateral Deviation of the Balise

The maximum lateral deviation between the Z reference mark of the Balise and the centre axis of the track ¹⁴ shall be as follows:

- In general up to a maximum system speed ¹⁵of 350 km/h ± 10 mm
- In straight lines for speed not exceeding 230 km/h ± 117.5 mm

H3.4.3 Presence of Metallic Objects

Underneath the Balise, there shall be no metallic objects that are closer than 130 mm.

H3.4.4 Distance Between Balises

The minimum longitudinal distance (direction X) between Balises is 3.0 m.

¹⁴ The centre axis of the track is located half the distance between the web of the rails. The value of the lateral tolerance does not include the influence from lateral rail wear. (This shall instead be considered in the dynamic displacement of the antenna unit, as specified in section 4.6.2 on page 49).

¹⁵ The system speed is the physical speed of the antenna versus the Balise.

Annex J, On-board Type 1 Specifics

J1 General

This annex applies to the Ebicab 700 and L 10000 systems only.

J2 Specific Safety Requirements

Antenna Tests shall be performed regularly. The time between succeeding tests shall not exceed 50 ms when not reading Balises.

J3 Safety Integrity Requirements

No.	Failure Mode Description	Balise group	
		WSF rate [f/h]	Unavailability
FM1 _G	A Balise Group is not detectable when indicating safe operation	$2 \cdot 10^{-11}$	-
FM2 _G	Storage of more than 31 bits of data, or data is not delivered in the same order as in the air-gap ¹⁶	10^{-9}	-
O1	On-board equipment too sensitive to Up-link	-	10^{-8}
O2	On-board equipment has too strong Tele-powering	-	10^{-8}

Table 22: Quantification for the Ebicab 700 and L 10000 systems

An SIL level of SIL 4 applies to the Ebicab 700 and L 10000 systems.

¹⁶ The definition of the failure mode together with the failure detection mechanisms in the STM function lead to the estimation that the total amount of corrupted messages is not significantly higher than what the STM function contributes with by failing with its decoding mechanisms (see Ref. [6], "Interface 'K' Specification").

J4 Contact Distance for Telegram Decoding

In order to ensure decoding of the telegram, a minimum of 168 consecutive error free bits are required. Please note that this implies that the bit stream is evaluated on a bit by bit basis. In general, this applies up to maximum system speed¹⁷ of 300 km/h. However, a specific installation needs only to support the applicable maximum vehicle speed.

J5 Antenna positioning along the x-axis

The maximum distance in the rear of the first axle shall be less than 6.5 m. The antenna positioning with respect to the front buffer shall comply with ERTMS/ETCS requirements defined in UNISIG SUBSET-040 (see Ref. [7], Engineering Rules).

¹⁷ The system speed is the physical speed of the antenna versus the Balise.

Annex K, On-board Type 2 Specifics

K1 General

This annex applies to the Ebicab 900 system only.

K2 Specific Safety Requirements

Antenna Tests shall be performed regularly. The time between succeeding tests shall not exceed 50 ms when not reading Balises.

K3 Safety Integrity Requirements

No.	Failure Mode Description	Balise group	
		WSF rate [f/h]	Unavailability
FM1 _G	A Balise Group is not detectable when indicating safe operation	$2 \cdot 10^{-11}$	-
FM2 _G	Storage of more than 31 bits of data, or data is not delivered in the same order as in the air-gap ¹⁸	10^{-9}	-
O1	On-board equipment too sensitive to Up-link	-	10^{-8}
O2	On-board equipment has too strong Tele-powering	-	10^{-8}

Table 23: Quantification for the Ebicab 900 system

An SIL level of SIL 4 applies to the Ebicab 900 system.

¹⁸ The definition of the failure mode together with the failure detection mechanisms in the STM function lead to the estimation that the total amount of corrupted messages is not significantly higher than what the STM function contributes with by failing with its decoding mechanisms (see Ref. [6], "Interface 'K' Specification").

K4 Contact Distance for Telegram Decoding

In order to ensure decoding of the telegram, a minimum of 272 consecutive error free bits are required. Please note that this implies that the bit stream is evaluated on a bit by bit basis. In general, this applies up to maximum system speed ¹⁹ of 300 km/h. However, a specific installation needs only to support the applicable maximum vehicle speed.

K5 Antenna positioning along the x-axis

The maximum distance in the rear of the first axle shall be less than 6.5 m. The antenna positioning with respect to the front buffer shall comply with ERTMS/ETCS requirements defined in UNISIG SUBSET-040 (see Ref. [7], Engineering Rules).

¹⁹ The system speed is the physical speed of the antenna versus the Balise.

Annex L, On-board Type 3 Specifics

L1 General

This annex applies to the RSDD system only.

L2 Specific Safety Requirements

Antenna Tests shall be performed regularly. The time between succeeding tests shall not exceed 100 ms when not reading Balises.

L3 Safety Integrity Requirements

No.	Failure Mode Description	Balise group	
		WSF rate [f/h]	Unavailability
FM1 _G	A Balise Group is not detectable when indicating safe operation	10 ⁻⁹	-
FM2 _G	Storage of more than 31 bits of data, or data is not delivered in the same order as in the air-gap ²⁰	10 ⁻¹¹	-
O1	On-board equipment too sensitive to Up-link	-	10 ⁻⁸
O2	On-board equipment has too strong Tele-powering	-	10 ⁻⁸

Table 24: Quantification for the RSDD system

An SIL level of SIL 4 applies to the RSDD system.

²⁰ The definition of the failure mode together with the failure detection mechanisms in the STM function lead to the estimation that the total amount of corrupted messages is not significantly higher than what the STM function contributes with by failing with its decoding mechanisms (see Ref. [6], "Interface 'K' Specification").

L4 Contact Distance for Telegram Decoding

In order to ensure decoding of the telegram, a minimum of 319 consecutive error free bits are required. In general, this applies up to maximum system speed²¹ of 300 km/h. However, a specific installation needs only to support the applicable maximum vehicle speed.

L5 Antenna positioning along the x-axis

The maximum distance in the rear of the first axle shall be less than 11 m. The antenna positioning with respect to the front buffer shall comply with ERTMS/ETCS requirements defined in UNISIG SUBSET-040 (see Ref. [7], Engineering Rules).

²¹ The system speed is the physical speed of the antenna versus the Balise.

Annex M, On-board Type 4 Specifics

M1 General

This annex applies to the KVB system only.

M2 Specific Safety Requirements

Antenna Tests shall be performed regularly. The time between succeeding tests shall not exceed 100 ms when not reading Balises.

It is not allowed to memorise more than 31 bits.

The minimum number of bits for Balise Detection is 64, excluding the time for the antenna test (32 bits). Consequently, the dimensioning requirement for the On-board transmission equipment is 96 bits or 1.92 ms.

M3 Safety Integrity Requirements

No.	Failure Mode Description	Balise group	
		WSF rate [f/h]	Unavailability
FM1 _G	A Balise Group is not detectable when indicating safe operation	10 ⁻⁶	-
FM2 _G	Storage of more than 31 bits of data, or data is not delivered in the same order as in the air-gap ²²	10 ⁻⁹	-
O1	On-board equipment too sensitive to Up-link	-	10 ⁻⁸
O2	On-board equipment has too strong Tele-powering	-	10 ⁻⁸

Table 25: Quantification for the KVB system

An SIL level of SIL 2 applies to the KVB system.

²² The definition of the failure mode together with the failure detection mechanisms in the STM function lead to the estimation that the total amount of corrupted messages is not significantly higher than what the STM function contributes with by failing with its decoding mechanisms (see Ref. [6], "Interface 'K' Specification").

M4 Contact Distance for Telegram Decoding

In order to ensure decoding of the telegram, a minimum of 320 consecutive error free bits are required at high speed. This applies up to maximum system speed ²³ of 350 km/h. However, a specific installation needs only to support the applicable maximum vehicle speed. At low speed, a minimum of 640 consecutive error free bits are required in order to be able to handle a potential telegram shift.

In the KVB system telegram shifts will be blocked during a Balise passage. The associated blocking time is sufficiently long in order not to impair normal Balise passages.

In order to achieve proper operation and maintain the existing availability target in KVB, and assuming that the original KVB algorithms are used, reception of bits should be as follows in Table 26 and Table 27 below. This information is included herein for information only. The minimum number of bits represent the amount needed for the original algorithms to succeed with decoding, and the typical amount of bits represent the amount needed for maintaining the existing availability target (empirically determined).

The bit error rate should be better than $6.25 \cdot 10^{-8}$ in the centre of the main lobe in order to maintain the existing availability target in KVB, while using the original KVB algorithms.

Speed [km/h]	Number of bits	Speed [km/h]	Number of bits
5	9064	180	320
10	4564	190	320
20	2314	200	320
30	1564	210	320
40	1189	220	320
50	964	230	320
60	814	240	320
70	707	250	320
80	627	260	320
90	564	270	320
100	514	280	320
110	473	290	320
120	439	300	320
130	410	310	320
140	320	320	320
150	320	330	320
160	320	340	320
170	320	350	320

Table 26: Minimum number of bits

²³ The system speed is the physical speed of the antenna versus the Balise.

Speed [km/h]	Number of bits	Speed [km/h]	Number of bits
5	25200	180	700
10	12600	190	663
20	6300	200	630
30	4200	210	600
40	3150	220	573
50	2520	230	548
60	2100	240	525
70	1800	250	504
80	1575	260	485
90	1400	270	467
100	1260	280	450
110	1145	290	434
120	1050	300	420
130	969	310	406
140	900	320	394
150	840	330	382
160	788	340	371
170	741	350	360

Table 27: Typical number of bits

It is a requirement for the STM to consider the start-up time of the Balise (i.e., the number of bits given in Table 26 and Table 27 above are based on static evaluation of required contact distance without consideration to start-up times).

M5 Antenna positioning along the x-axis

The maximum distance in the rear of the first axle shall be less than 12 m. The antenna positioning with respect to the front buffer shall comply with ERTMS/ETCS requirements defined in UNISIG SUBSET-040 (see Ref. [7], Engineering Rules).